

List of Tables

1	Guaranteed equality between μ and the upper bound	68
---	---	----

List of Figures

1	$M - \Delta$ Feedback Connection	68
2	Linear Fractional Transformation	68
3	General Star Product	68
4	Mass-Spring-Damper System	68
5	Example Interconnection of LFT's	69
6	Macroscopic representation of Figure 5	69
7	Scaling for Main Loop Theorem	69
8	Equivalent LFT's	70
9	Uncertain System for Robustness Tests	70
10	Uncertain System as an LFT	70

The Complex Structured Singular Value

Andy Packard
Mechanical Engineering
University of California
Berkeley, CA, USA 94720
pack@erg.berkeley.edu
(fax) 510.642.6163

John Doyle
Electrical Engineering, 116-81
Caltech
Pasadena, CA USA 91125
doyle@hot.caltech.edu

July 17, 1992, to appear, *Automatica*, January 1993

Abstract

A tutorial introduction to the complex structured singular value (μ) is presented, with an emphasis on the mathematical aspects of μ . The μ -based methods discussed here have been useful for analyzing the performance and robustness properties of linear feedback systems. Several tests for robust stability and performance with computable bounds for transfer functions and their state-space realizations are compared, and a simple synthesis problem is studied. Uncertain systems are represented using Linear Fractional Transformations (LFTs) which naturally unify the frequency-domain and state-space methods.

Subtitle: A tutorial introduction to the complex structured singular value (μ) is presented, with an emphasis on computable bounds and robust stability and performance tests for transfer functions and their state-space realizations.

Keywords: Computational methods, Control system analysis, Disturbance rejection, Frequency domain, Matrix algebra, Multivariable control systems, Performance bounds, Robust control, Sensitivity analysis, State-space methods.

1 Introduction

This paper gives a fairly complete introduction to the Structured Singular Value (μ) for complex perturbations. This paper is intended to be of tutorial value on the mathematical aspects of μ , and it is assumed that the reader is familiar with the control engineering motivation. The μ -based methods discussed here have been useful for analyzing the performance and robustness properties of linear feedback systems. The more elementary methods are now available in commercial software products and the manual (Balas, Doyle, et al, 1991) for one such product would serve as a tutorial introduction to the engineering motivation. The interested reader might also consult

the tutorial in (Stein and Doyle, 1991) or other application-oriented papers, such as (Skogestad, Morari, et al 1988). We present very few new results in this paper, although many of the results have appeared only in reports and conference proceedings. The paper is reasonably self-contained, skipping only those proofs which are readily available in the literature.

Section 3 begins with the definition of μ and some of its elementary properties, including simple bounds that form the basis for computational schemes. This section also introduces the relationship between the upper bound for μ and Linear Matrix Inequalities (LMIs), which results in a simple characterization of the convexity properties of the upper bound. The connections between μ and Linear Fractional Transformations are introduced in Section 4. These connections, especially the Main Loop Theorem, form the basis for most of the applications of μ to linear systems. In Section 5, using the definition of μ , and the Main Loop theorem, robust stability and robust performance theorems are derived for linear systems with structured linear fractional uncertainty.

Section 6 covers a maximum-modulus theorem for linear fractional transformations. Section 7 presents a generalization of the standard power algorithms for computing the spectral radius or maximum singular value of a matrix to the computation of μ . This power algorithm provides an attractive method for computing lower bounds for μ . Sections 8 and 9 considers issues associated with the upper bound, focusing particularly on conditions under which the upper bound is equal to μ . For certain simple block structures, this equality is guaranteed.

The remainder of the paper discusses applications of μ to problems motivated by control systems. Section 10 considers how various μ problems can be viewed in transfer function and state-space formulations. This leads to a variety of tests for robust performance, each with an interesting and useful interpretation. In Section 11, many (computable) necessary and sufficient conditions for quadratic stability of uncertain systems are given, for a wide variety of uncertainty structures. The proof techniques used in each different case are identical, giving a unifying treatment of many known and new results.

Section 12 considers a simple special case of μ -synthesis, the problem of minimizing μ as a function of some free parameter, such as a controller. Not surprisingly, μ -synthesis is a much harder problem than μ -analysis. For example, unlike μ -analysis problems, no method for minimizing the upper bound for μ in the synthesis problem using convex optimization has been found.

Finally, the paper outlines some related work in Section 13, beginning with a brief history of the early development of the μ theory. This outline is not intended to be exhaustive or complete, but simply to touch on a few of the topics nearest to this paper that were not considered in detail. LMIs are presented as potentially unifying theoretical and computational tools. The relationship between μ and quadratic versus L_1 notions of robust performance and robust stability is then discussed, followed by μ with mixed real and complex perturbations. The section ends with a discussion of model validation and generalizations of μ .

2 Notation

The notation is standard. \mathbf{R} denotes the set of real numbers; \mathbf{C} denotes the set of complex numbers; $|\cdot|$ is the absolute value of elements in \mathbf{R} or \mathbf{C} ; \mathbf{R}^n is the set of real n vectors; \mathbf{C}^n is the set of complex n vectors; $\|v\|$ is the Euclidean norm for $v \in \mathbf{C}^n$, $\|v\|^2 := \sum_{i=1}^n |v_i|^2$; l_2^n denotes the set of square summable sequences in \mathbf{C}^n ; $\|e\|_2$ is the l_2 norm of sequence $e \in l_2^n$, $\|e\|_2^2 := \sum_{k=1}^{\infty} \|e_k\|^2$; $\mathbf{R}^{n \times m}$ is the set of $n \times m$ real matrices; $\mathbf{C}^{n \times m}$ is the set of $n \times m$ complex matrices; \mathbf{H}^n is the set of Hermitian $n \times n$ complex matrices; I_n is a $n \times n$ identity matrix; and 0_n or $0_{n \times m}$ is an entirely zero matrix of obvious dimensions. For $M \in \mathbf{C}^{n \times m}$: M^T is the transpose of M ; M^* is the complex-conjugate transpose of M ; $\underline{\sigma}(M)$ is the minimum singular value of M ; $\sigma_i(M)$ is a singular value of M ; $\bar{\sigma}(M)$ is the maximum singular value of M . For $M \in \mathbf{C}^{n \times n}$: $\lambda_i(M)$ is an eigenvalue of M ; $\rho(M)$ is the spectral radius of M , $\rho(M) := \max_i |\lambda_i(M)|$; $\text{tr}(M)$ is the trace of M , $\text{tr}(M) := \sum_{i=1}^n M_{ii}$. If $M \in \mathbf{C}^{n \times n}$ satisfies $M = M^*$ then $M > 0$ denotes that M is positive definite, and $M^{\frac{1}{2}}$ denotes the unique positive definite Hermitian square root.

3 Structured Singular Value

This section is devoted to defining the structured singular value, a matrix function denoted by $\mu(\cdot)$. We consider matrices $M \in \mathbf{C}^{n \times n}$. In the definition of $\mu(M)$, there is an underlying structure Δ , (a prescribed set of block diagonal matrices) on which everything in the sequel depends. This structure may be defined differently for each problem depending on the **uncertainty** and **performance objectives** of the problem. Defining the structure involves specifying three things: the total number of blocks, the type of each block, and their dimensions.

In this paper, we consider two types of blocks—*repeated scalar* and *full* blocks. Two non-negative integers, S and F , denote the number of *repeated scalar* blocks and the number of *full* blocks, respectively. To bookkeep the block dimensions, we introduce positive integers $r_1, \dots, r_S; m_1, \dots, m_F$. The i 'th repeated scalar block is $r_i \times r_i$, while the j 'th full block is $m_j \times m_j$. With those integers given, define $\Delta \subset \mathbf{C}^{n \times n}$ as

$$\Delta = \{\text{diag} [\delta_1 I_{r_1}, \dots, \delta_S I_{r_S}, \Delta_{S+1}, \dots, \Delta_{S+F}] : \delta_i \in \mathbf{C}, \Delta_{S+j} \in \mathbf{C}^{m_j \times m_j}, 1 \leq i \leq S, 1 \leq j \leq F\} \quad (3.1)$$

For consistency among all the dimensions, we must have $\sum_{i=1}^S r_i + \sum_{j=1}^F m_j = n$. Often, we will need norm bounded subsets of Δ , and we introduce the notation

$$\mathbf{B}_\Delta = \{\Delta \in \Delta : \bar{\sigma}(\Delta) \leq 1\} \quad (3.2)$$

Note that in (3.1) all of the repeated scalar blocks appear first and the full blocks are square. This is done to keep the notation as simple as possible and can easily be relaxed.

Definition 3.1 For $M \in \mathbf{C}^{n \times n}$, $\mu_\Delta(M)$ is defined

$$\mu_\Delta(M) := \frac{1}{\min \{\bar{\sigma}(\Delta) : \Delta \in \Delta, \det(I - M\Delta) = 0\}} \quad (3.3)$$

unless no $\Delta \in \Delta$ makes $I - M\Delta$ singular, in which case $\mu_\Delta(M) := 0$.

Remark 3.2 The set Δ defines a multi-index of integers and vice versa, so it makes sense to identify as one object the set, the block structure, and the associated multi-index of integers and refer simply to a *block structure* Δ . Clearly, $\mu_{\Delta}(M)$ depends on the block structure Δ as well as the matrix M .

Remark 3.3 Without loss in generality, the full blocks in the minimal norm Δ can each be chosen to be dyads (rank = 1). To see this, first consider the case of only 1 full block, $\Delta = \mathbf{C}^{n \times n}$. Suppose that $I - M\Delta$ is singular. Then for some unit-norm vector $x \in \mathbf{C}^n$, $M\Delta x = x$. Define $y := \Delta x$. It follows that $y \neq 0$, and $\|y\| \leq \bar{\sigma}(\Delta)$. Hence, define a new perturbation, $\tilde{\Delta} \in \mathbf{C}^{n \times n}$ as

$$\tilde{\Delta} := yx^*$$

Note that $\bar{\sigma}(\tilde{\Delta}) = \|y\| \leq \bar{\sigma}(\Delta)$, and $y = \tilde{\Delta}x$, so that $I - M\tilde{\Delta}$ is also singular. Repeating this on a block-by-block basis allows for each full block to be a dyad.

Remark 3.4 It is instructive to consider a “feedback” interpretation of $\mu_{\Delta}(M)$ at this point. Let $M \in \mathbf{C}^{n \times n}$ be given, and consider the loop shown in Figure 1. This picture is meant to represent the loop equations $u = Mv, v = \Delta u$. As long as $I - M\Delta$ is nonsingular, the only solutions u, v to the loop equations are $u = v = 0$. However, if $I - M\Delta$ is singular, then there are infinitely many solutions to the equations, and the norms $\|u\|, \|v\|$ of the solutions can be arbitrarily large. Motivated by connections with stability of systems, which will be explored in detail in the sequel, we call this constant matrix feedback system “unstable”. Likewise, the term “stable” will describe the situation when the only solutions are identically zero. In this context then, $\mu_{\Delta}(M)$ provides a measure of the smallest structured Δ that causes “instability” of the constant matrix feedback loop in figure 1. The norm of this “destabilizing” Δ is exactly $1/\mu_{\Delta}(M)$.

Remark 3.5 It is immediate from the definition that for any $\alpha \in \mathbf{C}$, $\mu(\alpha M) = |\alpha|\mu(M)$. However, for all nontrivial block structures, the function $\mu: \mathbf{C}^{n \times n} \rightarrow \mathbf{R}$ is not a norm, since it doesn’t satisfy the triangle inequality.

Remark 3.6 A natural question is why we work with μ and not $1/\mu$, especially in view of equation 3.3 in the definition of μ . While it’s clearly a matter of taste, there are important reasons. Mathematically, μ is continuous and bounded and scales as indicated above. Perhaps more importantly, it connects more naturally with LFTs and generalizes the spectral radius and maximum singular value, as will be seen below.

An alternative expression for $\mu_{\Delta}(M)$ follows easily from the definition.

Lemma 3.7 $\mu_{\Delta}(M) = \max_{\Delta \in \mathbf{B}_{\Delta}} \rho(\Delta M)$

Proof: Since for any $\alpha \in \mathbf{C}$, $\mu_{\Delta}(\alpha M) = |\alpha|\mu_{\Delta}(M)$, we need only consider two cases: $\mu_{\Delta}(M) = 1$ iff $\max_{\Delta \in \mathbf{B}_{\Delta}} \rho(\Delta M) = 1$ and $\mu_{\Delta}(M) = 0$ iff $\max_{\Delta \in \mathbf{B}_{\Delta}} \rho(\Delta M) = 0$. These facts can be verified directly from the definition. ‡

This lemma implies continuity of the function $\mu: \mathbf{C}^{n \times n} \rightarrow \mathbf{R}$ based on continuity of the spectral radius and max functions, and the compactness of \mathbf{B}_Δ .

We can relate $\mu_\Delta(M)$ to familiar linear algebra quantities when Δ is one of two extreme sets:

- If $\Delta = \{\delta I : \delta \in \mathbf{C}\}$ ($S=1, F=0, r_1=n$), then $\mu_\Delta(M) = \rho(M)$, the spectral radius of M .

Proof: This follows immediately from Lemma 3.7. \sharp

- If $\Delta = \mathbf{C}^{n \times n}$ ($S=0, F=1, m_1=n$), then $\mu_\Delta(M) = \bar{\sigma}(M)$

Proof: If $\bar{\sigma}(\Delta) < \frac{1}{\bar{\sigma}(M)}$, then $\bar{\sigma}(M\Delta) < 1$, so $I - M\Delta$ is nonsingular. Applying equation (3.3) implies $\mu_\Delta(M) \leq \bar{\sigma}(M)$. On the other hand, let u and v be unit vectors satisfying $Mv = \bar{\sigma}(M)u$, and define $\Delta := \frac{1}{\bar{\sigma}(M)}vu^*$. Then $\bar{\sigma}(\Delta) = \frac{1}{\bar{\sigma}(M)}$ and $I - M\Delta$ is obviously singular. Hence, $\mu_\Delta(M) \geq \bar{\sigma}(M)$. \sharp

Obviously, for a general Δ as in (3.1) we must have $\{\delta I_n : \delta \in \mathbf{C}\} \subset \Delta \subset \mathbf{C}^{n \times n}$. Hence directly from the definition of μ , and the two special cases above, we conclude that

$$\rho(M) \leq \mu_\Delta(M) \leq \bar{\sigma}(M) \quad (3.4)$$

These bounds by themselves may provide little information on the value of μ , because the gap between ρ and $\bar{\sigma}$ can be arbitrarily large. They are refined with transformations on M that **do not affect** $\mu_\Delta(M)$, but **do affect** ρ and $\bar{\sigma}$. To do this, define two subsets of $\mathbf{C}^{n \times n}$

$$\mathbf{Q} = \{Q \in \Delta : Q^*Q = I_n\} \quad (3.5)$$

$$\mathbf{D} = \{\text{diag}[D_1, \dots, D_S, d_{S+1}I_{m_1}, \dots, d_{S+F}I_{m_F}] : D_i \in \mathbf{C}^{r_i \times r_i}, D_i = D_i^* > 0, d_{S+j} \in \mathbf{R}, d_{S+j} > 0\} \quad (3.6)$$

The reasons for taking \mathbf{D} positive will be clear shortly. Note that for any $\Delta \in \Delta, Q \in \mathbf{Q}$, and $D \in \mathbf{D}$,

$$Q^* \in \mathbf{Q} \quad Q\Delta \in \Delta \quad \Delta Q \in \Delta \quad \bar{\sigma}(Q\Delta) = \bar{\sigma}(\Delta Q) = \bar{\sigma}(\Delta) \quad (3.7)$$

$$D^{\frac{1}{2}}\Delta = \Delta D^{\frac{1}{2}} \quad (3.8)$$

Theorem 3.8 For all $Q \in \mathbf{Q}$ and $D \in \mathbf{D}$

$$\mu_\Delta(MQ) = \mu_\Delta(QM) = \mu_\Delta(M) = \mu_\Delta\left(D^{\frac{1}{2}}MD^{-\frac{1}{2}}\right) \quad (3.9)$$

Proof: For all $D \in \mathbf{D}$ and $\Delta \in \Delta$,

$$\det(I - M\Delta) = \det\left(I - MD^{-\frac{1}{2}}\Delta D^{\frac{1}{2}}\right) = \det\left(I - D^{\frac{1}{2}}MD^{-\frac{1}{2}}\Delta\right)$$

since D commutes with Δ . Therefore $\mu_\Delta(M) = \mu_\Delta\left(D^{\frac{1}{2}}MD^{-\frac{1}{2}}\right)$. Also, for each $Q \in \mathbf{Q}$, $\det(I - M\Delta) = 0$ if and only if $\det(I - MQQ^*\Delta) = 0$. Since $Q^*\Delta = \Delta$ and $\bar{\sigma}(Q^*\Delta) = \bar{\sigma}(\Delta)$, we get $\mu_\Delta(MQ) = \mu_\Delta(M)$ as desired. The argument for QM is the same. \sharp

Therefore, the bounds in (3.4) can be tightened to

$$\max_{Q \in \mathbf{Q}} \rho(QM) \leq \max_{\Delta \in \mathbf{B}\Delta} \rho(\Delta M) = \mu_{\Delta}(M) \leq \inf_{D \in \mathbf{D}} \bar{\sigma} \left(D^{\frac{1}{2}} M D^{-\frac{1}{2}} \right) \quad (3.10)$$

where the equality comes from Lemma 3.7. Note that in computing the infimum, any one of the diagonal entries of the elements of \mathbf{D} can be assumed to be equal to 1. This is without loss in generality, since for any nonzero scalar γ , $D^{\frac{1}{2}} M D^{-\frac{1}{2}} = (\gamma D)^{\frac{1}{2}} M (\gamma D)^{-\frac{1}{2}}$. Hence, from this point on, we assume that $d_{S+F} \equiv 1$. Also, using the polar decomposition theorem for invertible matrices, it is easy to see that restricting the elements of \mathbf{D} to be Hermitian, positive definite, as opposed to just invertible, does not affect the infimum. Certain convexity properties make the upper bound computationally attractive. For block structures with $S = 0$, it is shown by Safonov and Doyle, 1984, that by using an exponential parametrization of \mathbf{D} , the function $\bar{\sigma} \left(D^{\frac{1}{2}} M D^{-\frac{1}{2}} \right)$ is convex in $\log \left(D^{\frac{1}{2}} \right)$. In (Sezginer and Overton, 1990) a very elegant and simple proof shows that the function $\bar{\sigma} \left(e^X M e^{-X} \right)$ is convex on any convex set of commuting matrices \mathbf{X} . This generalizes the results in (Safonov and Doyle, 1984), and relies only on elementary linear algebra. The simplest convexity property is given in the following theorem, which shows that the function $\bar{\sigma} \left(D^{\frac{1}{2}} M D^{-\frac{1}{2}} \right)$ has convex level sets.

Theorem 3.9 *Let $M \in \mathbf{C}^{n \times n}$ be given, along with a scaling set \mathbf{D} , and $\beta > 0$. Then*

$$\left\{ D \in \mathbf{D} : \bar{\sigma} \left(D^{\frac{1}{2}} M D^{-\frac{1}{2}} \right) < \beta \right\}$$

is convex.

Proof: The following chain of equivalences comprises the proof:

$$\begin{aligned} \bar{\sigma} \left(D^{\frac{1}{2}} M D^{-\frac{1}{2}} \right) < \beta &\Leftrightarrow \lambda_{\max} \left(D^{-\frac{1}{2}} M^* D^{\frac{1}{2}} D^{\frac{1}{2}} M D^{-\frac{1}{2}} \right) < \beta^2 \\ &\Leftrightarrow D^{-\frac{1}{2}} M^* D^{\frac{1}{2}} D^{\frac{1}{2}} M D^{-\frac{1}{2}} - \beta^2 I < 0 \\ &\Leftrightarrow M^* D M - \beta^2 D < 0 \end{aligned} \quad (3.11)$$

The latter is clearly a convex condition in D . ‡

Remark 3.10 The final condition in equation (3.11) is called a *Linear Matrix Inequality* (LMI). Note that although it is equivalent to the condition in Theorem 3.9, the functional dependence on D is much simpler and makes the convexity property clearer. For these reasons, LMIs appear to be attractive for computation. General linear matrix inequalities are discussed in greater detail in Section 13.2

4 Linear Fractional Transformations and μ

The use of μ in control theory depends to a great extent on its intimate relationship with a class of general linear feedback loops called **Linear Fractional Transformations** (LFTs). This section

explores this relationship with some simple theorems that can be obtained almost immediately from the definition of μ . To introduce these, consider a complex matrix M partitioned as

$$M = \begin{bmatrix} M_{11} & M_{12} \\ M_{21} & M_{22} \end{bmatrix} \quad (4.1)$$

and suppose there is a defined block structure $\mathbf{\Delta}_2$ which is compatible in size with M_{22} (for any $\Delta_2 \in \mathbf{\Delta}_2$, $M_{22}\Delta_2$ is square). For $\Delta_2 \in \mathbf{\Delta}_2$, consider the loop equations

$$\begin{aligned} e &= M_{11}d + M_{12}w \\ z &= M_{21}d + M_{22}w \\ w &= \Delta_2 z \end{aligned} \quad (4.2)$$

which correspond to the block diagram in Figure 2.

Definition 4.1 *Given complex matrices M and Δ_2 as described above. This set of equations (4.2) is called **well posed** if for any vector d , there exist unique vectors w , z , and e satisfying the loop equations.*

It is easy to see that the set of equations is well posed if and only if the inverse of $I - M_{22}\Delta_2$ exists. If this inverse does not exist, then depending on d and M , there is either no solution to the loop equations, or there are an infinite number of solutions. When the inverse does exist, the vectors e and d satisfy $e = \mathcal{S}(M, \Delta_2)d$, where

$$\mathcal{S}(M, \Delta_2) := M_{11} + M_{12}\Delta_2(I - M_{22}\Delta_2)^{-1}M_{21} \quad (4.3)$$

$\mathcal{S}(M, \Delta_2)$ is called a **Linear Fractional Transformation** (LFT). If $\mathbf{\Delta}_1$ is a block structure compatible in dimension with M_{11} , then for $\Delta_1 \in \mathbf{\Delta}_1$ an analogous formula describes $\mathcal{S}(\Delta_1, M)$,

$$\mathcal{S}(\Delta_1, M) := M_{22} + M_{21}\Delta_1(I - M_{11}\Delta_1)^{-1}M_{12}$$

where the upper loop of M is closed with a matrix Δ_1 .

The $\mathcal{S}(M, \Delta_2)$ and $\mathcal{S}(\Delta_1, M)$ notation can be somewhat confusing on first encounter. It comes from the “star-product” of Redheffer. Suppose that Q and M are complex matrices, partitioned as

$$Q = \begin{bmatrix} Q_{11} & Q_{12} \\ Q_{21} & Q_{22} \end{bmatrix}, \quad M = \begin{bmatrix} M_{11} & M_{12} \\ M_{21} & M_{22} \end{bmatrix}$$

with the matrix product $Q_{22}M_{11}$ well defined and square. If $I - Q_{22}M_{11}$ is invertible, then the block diagram in Figure 3 is well-defined. We can extend the definition of \mathcal{S} so that it equals the result of this interconnection,

$$\begin{bmatrix} y_1 \\ y_2 \end{bmatrix} = \mathcal{S}(Q, M) \begin{bmatrix} u_1 \\ u_2 \end{bmatrix}$$

Simple manipulation gives

$$\mathcal{S}(Q, M) := \begin{bmatrix} \mathcal{S}(Q, M_{11}) & Q_{12}(I - M_{11}Q_{22})^{-1}M_{12} \\ M_{21}(I - Q_{22}M_{11})^{-1}Q_{21} & \mathcal{S}(Q_{22}, M) \end{bmatrix}$$

where $\mathcal{S}(Q, M_{11})$ and $\mathcal{S}(Q_{22}, M)$ are defined as above. Note that this definition is dependent on the partitioning of the matrices Q and M above; it may be well defined for one partition and not well defined for another.

For clarity, the notation $\mathcal{S}(\bullet, \bullet)$ should have 2 additional arguments, specifying dimensions of the partitions. However, in this paper, the only situations using \mathcal{S} that will arise are LFTs, namely

1. the number of rows of Q is less than the number of columns of M , and the number of columns of Q is smaller than the number of rows of M , **or**;
2. the number of columns of M is less than the number of rows of Q , and the number of rows of M is smaller than the number of columns of Q ,

and all inputs/outputs into the (dimensionally) smaller matrix are closed in the interconnecting transformation. Hence, we do not need to specify the dimensions of the interconnecting channels, since they are equal to the dimension of the smaller matrix.

Alternative notation for LFTs has been used in previous papers, most notably

$$\mathcal{S}(M, \Delta_2) = \mathcal{F}_l(M, \Delta_2), \quad \mathcal{S}(\Delta_1, M) = \mathcal{F}_u(M, \Delta_1)$$

where l and u indicate that the lower and upper loop, respectively, are closed. We believe that the \mathcal{S} notation is more natural, easier to work with, and generalizes smoothly to $\mathcal{S}(M, Q)$ in figure 3.

4.1 Examples of LFTs

Given the state space realization of a discrete time system

$$\begin{bmatrix} x_{k+1} \\ y_k \end{bmatrix} = \begin{bmatrix} A & B \\ C & D \end{bmatrix} \begin{bmatrix} x_k \\ u_k \end{bmatrix} = M \begin{bmatrix} x_k \\ u_k \end{bmatrix} \quad (4.4)$$

then its transfer matrix is

$$G(z) = D + C(zI - A)^{-1}B = \mathcal{S}\left(\frac{1}{z}I, M\right)$$

Systems with uncertainty can also be easily represented using LFTs. One natural type of uncertainty is unknown coefficients in a state space model. As a simple example, we will begin with a familiar idealized mass/spring/damper system shown in Figure 4. Suppose m, c , and k are fixed but uncertain, with $m = \bar{m}(1 + w_m\delta_m)$, $c = \bar{c}(1 + w_c\delta_c)$, $k = \bar{k}(1 + w_k\delta_k)$. Then defining $x_1 = y$ and $x_2 = \dot{y}$ we can write the differential equation in state-space form as

$$\begin{bmatrix} \dot{x} \\ y \end{bmatrix} = \mathcal{S}(M, \Delta) \begin{bmatrix} x \\ F \end{bmatrix} \quad \Delta = \text{diag}(\delta_m, \delta_c, \delta_k)$$

$$M = \begin{bmatrix} 0 & 1 & 0 & 0 & 0 & 0 \\ \frac{-\bar{k}}{\bar{m}} & \frac{-\bar{c}}{\bar{m}} & \frac{1}{\bar{m}} & -w_m & \frac{-w_c}{\bar{m}} & \frac{-w_k}{\bar{m}} \\ 1 & 0 & 0 & 0 & 0 & 0 \\ \frac{-\bar{k}}{\bar{m}} & \frac{-\bar{c}}{\bar{m}} & \frac{1}{\bar{m}} & -w_m & \frac{-w_c}{\bar{m}} & \frac{-w_k}{\bar{m}} \\ 0 & \bar{c} & 0 & 0 & 0 & 0 \\ \bar{k} & 0 & 0 & 0 & 0 & 0 \end{bmatrix}$$

More generally, the perturbed state-space system

$$\begin{aligned} x_{k+1} &= A(\delta)x_k + B(\delta)d_k \\ e_k &= C(\delta)x_k + D(\delta)d_k \end{aligned}$$

where δ is a vector of parameters that enter rationally can be written as an LFT on a diagonal matrix Δ made up of the elements of δ , possibly repeated. The form of the LFT is (Morton and McAfoos, 1985)

$$\begin{bmatrix} x_{k+1} \\ e_k \\ z_k \end{bmatrix} = \begin{bmatrix} M_{11} & M_{12} & M_{13} \\ M_{21} & M_{22} & M_{23} \\ M_{31} & M_{32} & M_{33} \end{bmatrix} \begin{bmatrix} x_k \\ d_k \\ w_k \end{bmatrix}$$

with perturbation $w_k = \Delta z_k$ yielding

$$\begin{bmatrix} x_{k+1} \\ e_k \end{bmatrix} = \mathcal{S}(M, \Delta) \begin{bmatrix} x_k \\ d_k \end{bmatrix}$$

In general, for problems of this type it is easy to obtain realizations, but it is difficult to insure that they are minimal, except in the case where the parameters enter linearly.

A fundamental property of LFTs that contributes to their importance in linear systems theory is that interconnections of LFTs are again LFTs. For example, consider a situation with three components, each with a LFT uncertainty model. The interconnection is shown in Figure 5. By simply reorganizing the diagram, collecting all of the known systems together, and collecting all of the perturbations (the Δ_i 's) together, we end up with the diagram in Figure 6, where P depends only on G_1, G_2, G_3 and the diagram layout. Note how general uncertainty at the component level becomes *structured uncertainty at the system level*. Additional information on LFT's and how they arise in engineering problems is found in (Doyle, Packard, et al, 1991).

4.2 The Main Loop Theorem

For notational ease, let $\mathbf{B}_i := \{\Delta_i \in \mathbf{\Delta}_i : \bar{\sigma}(\Delta_i) \leq 1\}$. In this formulation, the matrix $M_{11} = \mathcal{S}(M, 0)$ may be thought of as the nominal map and $\Delta_2 \in \mathbf{B}_2$ viewed as a norm bounded perturbation from an allowable perturbation class, $\mathbf{\Delta}_2$. The matrices M_{12}, M_{21} , and M_{22} and the formula $\mathcal{S}(M, \bullet)$ reflect prior knowledge on how the unknown perturbation affects the nominal map, M_{11} . This type of uncertainty, called *linear fractional*, is natural for many control problems, and encompasses many other special cases considered by researchers in robust control and matrix perturbation theory.

The constant matrix problem to solve is: determine whether the LFT is well posed for all Δ_2 in \mathbf{B}_2 and, if so, then determine how “large” $\mathcal{S}(M, \Delta_2)$ can get for $\Delta_2 \in \mathbf{B}_2$.

Define a third structure $\mathbf{\Delta}$ as

$$\mathbf{\Delta} := \left\{ \begin{bmatrix} \Delta_1 & 0 \\ 0 & \Delta_2 \end{bmatrix} : \Delta_1 \in \mathbf{\Delta}_1, \Delta_2 \in \mathbf{\Delta}_2 \right\} \quad (4.5)$$

Now there are three structures with respect to which we may compute μ . The notation we use to keep track is as follows: $\mu_1(\cdot)$ is with respect to $\mathbf{\Delta}_1$, $\mu_2(\cdot)$ is with respect to $\mathbf{\Delta}_2$, $\mu_{\mathbf{\Delta}}(\cdot)$ is with respect to $\mathbf{\Delta}$. In view of this, $\mu_1(M_{11})$, $\mu_2(M_{22})$ and $\mu_{\mathbf{\Delta}}(M)$ are all defined, though for instance, $\mu_1(M)$ is not defined. The first theorem follows immediately from the definition of μ .

Theorem 4.2 *The linear fractional transformation $\mathcal{S}(M, \Delta_2)$ is well posed for all $\Delta_2 \in \mathbf{B}_2$ if and only if $\mu_2(M_{22}) < 1$.*

As the perturbation Δ_2 deviates from zero, the matrix $\mathcal{S}(M, \Delta_2)$ deviates from M_{11} . The range of values that $\mu_1(\mathcal{S}(M, \Delta_2))$ takes on is intimately related to $\mu_{\mathbf{\Delta}}(M)$, as follows:

Theorem 4.3 (Main Loop theorem)

$$\mu_{\mathbf{\Delta}}(M) < 1 \quad \iff \quad \begin{cases} \mu_2(M_{22}) < 1 \\ \max_{\Delta_2 \in \mathbf{B}_2} \mu_1(\mathcal{S}(M, \Delta_2)) < 1 \end{cases}$$

Proof: First note that $\mu_{\mathbf{\Delta}}(M) < 1$ implies that $\mu_2(M_{22}) < 1$, so we may assume the latter and prove the equivalence of the two remaining conditions. Let $\Delta_i \in \mathbf{\Delta}_i$ be given, with $\bar{\sigma}(\Delta_i) \leq 1$, and define $\Delta = \text{diag} [\Delta_1, \Delta_2]$ so that $\Delta \in \mathbf{\Delta}$. Now

$$\det(I - M\Delta) = \det \begin{bmatrix} I - M_{11}\Delta_1 & -M_{12}\Delta_2 \\ -M_{21}\Delta_1 & I - M_{22}\Delta_2 \end{bmatrix} \quad (4.6)$$

By hypothesis $I - M_{22}\Delta_2$ is invertible, hence

$$\det(I - M\Delta) = \det(I - M_{22}\Delta_2) \det \left(I - M_{11}\Delta_1 - M_{12}\Delta_2 (I - M_{22}\Delta_2)^{-1} M_{21}\Delta_1 \right).$$

Collecting the Δ_1 terms leaves

$$\det(I - M\Delta) = \det(I - M_{22}\Delta_2) \det(I - \mathcal{S}(M, \Delta_2) \Delta_1) \quad (4.7)$$

By the definition of μ , the left-hand side of (4.7) is nonzero for all $\Delta \in \mathbf{B}_{\mathbf{\Delta}}$ iff $\mu_{\mathbf{\Delta}}(M) < 1$. Similarly, the right hand side is nonzero for all $\Delta = \text{diag} [\Delta_1, \Delta_2] \in \mathbf{B}_{\mathbf{\Delta}}$ iff $\mu_1(\mathcal{S}(M, \Delta_2)) < 1$ for all $\Delta_2 \in \mathbf{B}_2$. This completes the proof. \sharp

Remark 4.4 This theorem forms the basis for most uses of μ in linear system robustness analysis, whether from a state-space, frequency domain, or Lyapunov approach.

Remark 4.5 This theorem is stated in terms of feasibility conditions, testing whether some quantity is less than 1. This allows for an elegant statement and proof, but other versions are possible, with some complication in notation. Scaled versions of the Main Loop Theorem appear later in this section.

Remark 4.6 The importance of the theorem can be highlighted by a slight restatement. Suppose a property \mathcal{P} , of a matrix W can be related to a μ test on the matrix. That is, there exists some block structure $\Delta_{\mathcal{P}}$ such that

$$\text{matrix } W \text{ satisfies property } \mathcal{P} \quad \Leftrightarrow \quad \mu_{\Delta_{\mathcal{P}}}(W) < 1$$

Then the perturbed matrix $\mathcal{S}(M, \Delta)$ is well defined, and has the property \mathcal{P} for every $\Delta \in \mathbf{B}_{\Delta}$ if and only if $\mu_{\tilde{\Delta}}(M) < 1$, where $\tilde{\Delta} := \{\text{diag}[\Delta_{\mathcal{P}}, \Delta] : \Delta_{\mathcal{P}} \in \Delta_{\mathcal{P}}, \Delta \in \Delta\}$. In other words, whenever a property of a matrix can be related to a μ test, then there will be a μ test of greater complexity to determine if the property is robust to structured perturbations in the form of LFTs.

The role of the block structure Δ_2 is clear in this theorem — it is the structure for the original perturbation. However the role of the perturbation structure Δ_1 is often misunderstood. Note that $\mu_1(\cdot)$ appears on the right hand side of the theorem, so that the set Δ_1 **defines** what function of the matrix $\mathcal{S}(M, \Delta_2)$ is to be computed.

This theorem can be illustrated by a system-theoretic example with a transfer function and its state-space realization. This example involves two of the simplest cases of LFTs. Suppose that $\Delta_1 := \{\delta_1 I_n : \delta_1 \in \mathbf{C}\}$ and $\Delta_2 = \mathbf{C}^{m \times m}$, which are the special cases considered in Section 3. Recall that for $A \in \mathbf{C}^{n \times n}$, $\mu_1(A) = \rho(A)$, and for $D \in \mathbf{C}^{m \times m}$, $\mu_2(D) = \bar{\sigma}(D)$. Now, let Δ be the diagonal augmentation Δ_1 and Δ_2 , namely

$$\Delta := \left\{ \begin{bmatrix} \delta_1 I_n & 0_{n \times m} \\ 0_{m \times n} & \Delta_2 \end{bmatrix} : \delta_1 \in \mathbf{C}, \Delta_2 \in \mathbf{C}^{m \times m} \right\} \subset \mathbf{C}^{(n+m) \times (n+m)}$$

Let $A \in \mathbf{C}^{n \times n}$, $B \in \mathbf{C}^{n \times m}$, $C \in \mathbf{C}^{m \times n}$, and $D \in \mathbf{C}^{m \times m}$, be given, and interpret them as the state space model of a discrete time system

$$\begin{aligned} x_{k+1} &= Ax_k + Bu_k \\ y_k &= Cx_k + Du_k \end{aligned}$$

and let $M \in \mathbf{C}^{(n+m) \times (n+m)}$ be the block state space matrix of the system,

$$M = \begin{bmatrix} A & B \\ C & D \end{bmatrix}$$

Applying the theorem with this data implies that the following are equivalent:

- The spectral radius of A satisfies $\rho(A) < 1$, and

$$\max_{\substack{\delta_1 \in \mathbf{C} \\ |\delta_1| \leq 1}} \bar{\sigma}(D + C\delta_1(I - A\delta_1)^{-1}B) < 1$$

- The maximum singular value of D satisfies $\bar{\sigma}(D) < 1$, and

$$\max_{\substack{\Delta_2 \in \mathbf{C}^{m \times m} \\ \bar{\sigma}(\Delta_2) \leq 1}} \rho \left(A + B\Delta_2 (I - D\Delta_2)^{-1} C \right) < 1$$

- The structured singular value of M satisfies $\mu_{\Delta}(M) < 1$.

The first condition implies two things: the system is stable, and the $\|\cdot\|_{\infty}$ norm on the transfer function from u to y obtained by setting $\delta_1 = \frac{1}{z}$ is less than 1. That is

$$\|G\|_{\infty} := \max_{\substack{z \in \mathbf{C} \\ |z| \geq 1}} \bar{\sigma} \left(D + C(zI - A)^{-1} B \right) = \max_{\substack{\delta_1 \in \mathbf{C} \\ |\delta_1| \leq 1}} \bar{\sigma} \left(D + C\delta_1 (I - A\delta_1)^{-1} B \right) < 1$$

The second condition implies that $(I - D\Delta_2)^{-1}$ is well defined for all $\bar{\sigma}(\Delta_2) \leq 1$, and that the uncertain difference equation

$$x_{k+1} = \left(A + B\Delta_2 (I - D\Delta_2)^{-1} C \right) x_k$$

is stable for all such Δ_2 .

The equivalence between the small gain condition, $\|G\|_{\infty} < 1$, and the stability robustness of the uncertain difference equation is well known as the small gain theorem, in its necessary and sufficient form for linear time invariant systems. What is important to see is that both of these conditions are in fact equivalent to one condition on the structured singular value. Already we have seen that the spectral radius and maximum singular value are special cases of μ . Here we see that additional important linear system properties, namely robust stability and input-output gain are also related to a particular case of the structured singular value.

Returning to the main loop theorem, note that the bound on the performance is the same as the bound on the perturbation, namely 1. Scaling the matrix M by $\frac{1}{\beta}$, for some positive scalar β , and then applying the theorem gives:

Corollary 4.7 *Let $\beta > 0$ be given. Then*

$$\mu_{\Delta}(M) < \beta \quad \iff \quad \begin{cases} \mu_2(M_{22}) < \beta \\ \max_{\Delta_2 \in \frac{1}{\beta} \mathbf{B}_2} \mu_1(\mathcal{S}(M, \Delta_2)) < \beta \end{cases}$$

The bound on performance and the bound on the perturbation are related, they are reciprocals. For nonreciprocal values, certain blocks of M must be scaled and μ recomputed. Specifically, for $\alpha \geq 0$, define \mathbf{M}_{α} as

$$\mathbf{M}_{\alpha} = \begin{bmatrix} \alpha M_{11} & \sqrt{\alpha} M_{12} \\ \sqrt{\alpha} M_{21} & M_{22} \end{bmatrix} \quad (4.8)$$

Some simple facts about \mathbf{M}_{α} :

1. if $\alpha = 0$ then $\mu_{\Delta}(\mathbf{M}_{\alpha}) = \mu_2(M_{22})$

2. for any $\Delta_2 \in \mathbf{\Delta}_2$, with $I - M_{22}\Delta_2$ nonsingular, $\mathcal{S}(\mathbf{M}_\alpha, \Delta_2) = \alpha\mathcal{S}(M, \Delta_2)$
3. $\max\{\alpha\mu_1(M_{11}), \mu_2(M_{22})\} \leq \mu_\Delta(\mathbf{M}_\alpha) \leq \max\{1, \alpha\}\mu_\Delta(M)$
4. $\mu_\Delta(\mathbf{M}_\alpha)$ is a continuous, nondecreasing function of α

Theorem 4.8 *Let $\beta > \mu_2(M_{22})$ be given, and $\alpha_\beta := \max\{\alpha > 0 : \mu_\Delta(\mathbf{M}_\alpha) = \beta\}$. Then*

$$\max_{\Delta_2 \in \frac{1}{\beta}\mathbf{B}_2} \mu_1(\mathcal{S}(M, \Delta_2)) = \frac{\beta}{\alpha_\beta} \quad (4.9)$$

4.3 Upper bound LFT results

Theorem 4.3 gives necessary and sufficient conditions for performance/robustness characteristics in terms of a μ evaluation. The μ test always takes on the form “Is $\mu(M) < 1$?” Hence, upper and lower bounds on μ can be used in the following manner: an upper bound gives a sufficient condition for the robustness/performance characteristic of the theorem; a lower bound gives a sufficient condition for when the robustness/performance **will not** be met. Clearly, both are important. The upper bound guarantees robustness of a property of a linear fractional transformation for perturbations up to a certain size, and a lower bound exhibits perturbations which cause a degree of degradation in the LFT’s properties.

The above comments apply for **any** upper and lower bound. Of specific interest is the additional information that is obtained in using the $\bar{\sigma}(D^{\frac{1}{2}}MD^{-\frac{1}{2}})$ upper bound. Generally $\bar{\sigma}(D^{\frac{1}{2}}MD^{-\frac{1}{2}}) < 1$ implies a great deal more than $\mu_\Delta(M) < 1$. As usual, let $\mathbf{\Delta}_1$ and $\mathbf{\Delta}_2$ be two given structures, and let $\mathbf{\Delta} = \{\text{diag}[\Delta_1, \Delta_2] : \Delta_i \in \mathbf{\Delta}_i\}$. Similarly, let \mathbf{D}_i be the appropriate D scaling sets for the two structures, (equation 3.6) and denote \mathbf{D} as the diagonal augmentation of these two sets, $\mathbf{D} := \{\text{diag}[D_1, D_2] : D_i \in \mathbf{D}_i\}$.

Lemma 4.9 ((Redheffer, 1959, 1960)) *Let M be given as in equation 4.1. Suppose there is a $D \in \mathbf{D}$ such that $\bar{\sigma}(D^{\frac{1}{2}}MD^{-\frac{1}{2}}) < 1$. Then there exists a $D_1 \in \mathbf{D}_1$ such that*

$$\max_{\Delta_2 \in \mathbf{B}_2} \bar{\sigma}\left(D_1^{\frac{1}{2}}\mathcal{S}(M, \Delta_2)D_1^{-\frac{1}{2}}\right) < 1$$

Proof: The easiest method of proof is just to track the norms of the various vectors in the loop equations for the linear fractional transformations shown in Figure 8. Let D_1 and D_2 be the separate parts of the $D \in \mathbf{D}$ which achieves $\bar{\sigma}(D^{\frac{1}{2}}MD^{-\frac{1}{2}}) < 1$. Obviously, $\mu_2(M_{22}) < 1$, so for any $\Delta_2 \in \mathbf{B}_2$ the two LFT’s are well posed, and from d to e are the same. Let $d \neq 0$ be any given complex vector of appropriate dimension, and let e, w , and z be the unique solutions to the loop equations for the linear fractional transformation on the right in Figure 8. By hypothesis, we have

$$\|z\|^2 + \|e\|^2 < \|w\|^2 + \|d\|^2 \quad (4.10)$$

and since $\bar{\sigma}(\Delta_2) \leq 1$

$$\|w\|^2 \leq \|z\|^2 \quad (4.11)$$

Combining these gives

$$\|e\|^2 < \|d\|^2 \quad (4.12)$$

Equation (4.12) also holds for the linear fractional transformation on the left, since the matrix relating d to e is the same for both linear fractional transformations. This implies that $\bar{\sigma} \left(D_1^{\frac{1}{2}} \mathcal{S}(M, \Delta_2) D_1^{-\frac{1}{2}} \right) < 1$ as desired. \sharp

Consider the problem determining the value of

$$\inf_{D_1 \in \mathbf{D}_1} \max_{\Delta_2 \in \mathbf{B}_2} \bar{\sigma} \left(D_1^{\frac{1}{2}} \mathcal{S}(M, \Delta_2) D_1^{-\frac{1}{2}} \right) \quad (4.13)$$

and also finding a $D_1 \in \mathbf{D}_1$ that achieves a cost arbitrarily close to the infimum. Suppose the dimension of M_{11} is $n \times n$. Define an additional structure

$$\mathbf{\Delta}_N := \{ \text{diag} [\Delta, \Delta_2] : \Delta \in \mathbf{C}^{n \times n}, \Delta_2 \in \mathbf{\Delta}_2 \} \quad (4.14)$$

Theorem 4.10 *Let M , $\mathbf{\Delta}_2$, \mathbf{D}_1 , and $\mathbf{\Delta}_N$ be given as above. Suppose that $\mu_2(M_{22}) < 1$. Define $\bar{\alpha}$ by*

$$\bar{\alpha} = \sup_{\alpha > 0} \left\{ \alpha : \inf_{D_1 \in \mathbf{D}_1} \mu_{\mathbf{\Delta}_N} \left(\begin{bmatrix} D_1^{\frac{1}{2}} & 0 \\ 0 & I \end{bmatrix} \begin{bmatrix} \alpha M_{11} & \sqrt{\alpha} M_{12} \\ \sqrt{\alpha} M_{21} & M_{22} \end{bmatrix} \begin{bmatrix} D_1^{-\frac{1}{2}} & 0 \\ 0 & I \end{bmatrix} \right) < 1 \right\} \quad (4.15)$$

Then

$$\inf_{D_1 \in \mathbf{D}_1} \max_{\Delta_2 \in \mathbf{B}_2} \bar{\sigma} \left(D_1^{\frac{1}{2}} \mathcal{S}(M, \Delta_2) D_1^{-\frac{1}{2}} \right) = \frac{1}{\bar{\alpha}} \quad (4.16)$$

In this section, all of the results were stated for $\mathcal{S}(M, \Delta_2)$. Analogous results hold for $\mathcal{S}(\Delta_1, M)$.

5 Robustness tests with μ

The structured singular value can be used to quantify robustness margins for a linear system with linear fractional uncertainty. Specifically, suppose that $P(s)$ is a rational, proper matrix, of size $(n_1 + n_2) \times (n_1 + n_2)$ and block structures $\mathbf{\Delta}_1 \subset \mathbf{C}^{n_1 \times n_1}$ and $\mathbf{\Delta}_2 \subset \mathbf{C}^{n_2 \times n_2}$ are given. Partition $P(s)$ as

$$P(s) = \begin{bmatrix} P_{11}(s) & P_{12}(s) \\ P_{21}(s) & P_{22}(s) \end{bmatrix}.$$

For $\Delta_1 \in \mathbf{\Delta}_1$, consider the interconnection shown in Figure 9. For any $\Delta_1 \in \mathbf{B}_1$, $\mathcal{S}(\Delta_1, P(s))$ is the transfer function from $d_3 \rightarrow e_3$. The closed-loop system is said to be:

- **well-posed** if $\det(I - P_{11}(\infty)\Delta_1) \neq 0$. This is the necessary and sufficient condition that all closed-loop transfer functions in Figure 5.1 be proper.
- **stable** if all closed-loop transfer functions in Figure 5.1 are analytic in the closed right-half-plane.

Theorem 5.1 *Suppose that $P(s)$ has all of its poles in the open left-half plane. Let $\beta > 0$. Then*

1. *For all $\Delta_1 \in \mathbf{\Delta}_1$ with $\bar{\sigma}(\Delta_1) \leq \beta$, the perturbed closed-loop system is well-posed and stable if and only if*

$$\sup_{\operatorname{Re}(s) \geq 0} \mu_1(P_{11}(s)) < \frac{1}{\beta}.$$

2. *For all $\Delta_1 \in \mathbf{\Delta}_1$ with $\bar{\sigma}(\Delta_1) \leq \beta$, the perturbed closed-loop system is well-posed, stable and*

$$\sup_{\operatorname{Re}(s) \geq 0} \mu_2[\mathcal{S}(\Delta_1, P(s))] < \frac{1}{\beta}$$

if and only if

$$\sup_{\operatorname{Re}(s) \geq 0} \mu_{\mathbf{\Delta}}(P(s)) < \frac{1}{\beta}.$$

Proof: The proof follows from the definitions of μ , well-posedness, stability, and invertibility of matrices with elements in a commutative ring. \sharp

Remark 5.2 Although the structured singular value is **not necessarily a norm**, we introduce the following notation: for a proper, rational matrix P , analytic in the closed-right-half-plane, and a block structure $\mathbf{\Delta}$ of appropriate dimensions, define

$$\|P\|_{\mathbf{\Delta}} := \sup_{\operatorname{Re}(s) \geq 0} \mu_{\mathbf{\Delta}}(P(s)).$$

Remark 5.3 In Section 6, techniques that allow the right-half plane supremums to be replaced (equivalently) by imaginary-axis supremums will be developed.

It is possible to easily generalize these robustness theorems to the case where Δ is a block-diagonal, finite dimensional, stable, linear time-invariant system (as opposed to a constant, complex matrix). Let $\mathbf{\Delta}$ be a block structure, as in equation 3.1. We want to consider feedback perturbations to P which are themselves dynamical systems, with the block-diagonal structure of the set $\mathbf{\Delta}$. To do so, first let $\mathcal{M}(\mathbf{S})$ denote the set of rational, proper, stable, transfer matrices. Associated with any block structure $\mathbf{\Delta}$, let $\mathcal{M}(\mathbf{\Delta})$ denote the set of all block diagonal, stable rational transfer functions, with block structure like $\mathbf{\Delta}$.

$$\mathcal{M}(\mathbf{\Delta}) := \{\Delta(\cdot) \in \mathcal{M}(\mathbf{S}) : \Delta(s_o) \in \mathbf{\Delta} \text{ for all } s_o \in \bar{\mathbf{C}}_+\}$$

For any $\Delta_1 \in \mathcal{M}(\mathbf{\Delta}_1)$, the closed-loop system is said to be:

- **well-posed** if $\det(I - P_{11}(\infty)\Delta_1(\infty)) \neq 0$. This is the necessary and sufficient condition that all closed-loop transfer functions in Figure 5.1 be proper.
- **stable** if all closed-loop transfer functions in Figure 5.1 are analytic in the closed right-half-plane.

Theorem 5.4 *Suppose that $P(s)$ has all of its poles in the open left-half plane. Let $\beta > 0$. Then*

1. *For all $\Delta_1 \in \mathcal{M}(\mathbf{\Delta}_1)$ with $\|\Delta_1\|_\infty \leq \beta$, the perturbed closed-loop system is well-posed and stable if and only if*

$$\sup_{\operatorname{Re}(s) \geq 0} \mu_1(P_{11}(s)) < \frac{1}{\beta}.$$

2. *For all $\Delta_1 \in \mathcal{M}(\mathbf{\Delta}_1)$ with $\|\Delta_1\|_\infty \leq \beta$, the perturbed closed-loop system is well-posed, stable and*

$$\sup_{\operatorname{Re}(s) \geq 0} \mu_2[\mathcal{S}(\Delta_1(s), P(s))] < \frac{1}{\beta}$$

if and only if

$$\sup_{\operatorname{Re}(s) \geq 0} \mu_{\mathbf{\Delta}}(P(s)) < \frac{1}{\beta}.$$

In summary, the peak value on the μ plot of the frequency response that the perturbation “sees” determines the size of perturbations that the loop is robustly stable (and/or performing) against.

Other, more sophisticated assumptions about the perturbations may be formulated, and solved with μ . These include gap/graph topology uncertainty, (Foo and Postlethwaite, 1988), (Khar-gonekar and Kaminer, 1991), and different induced norms to measure the size of the uncertainty, (Bamieh and Dahleh, 1992).

6 Maximum modulus theorem for LFT’s with μ

This section describes a maximum modulus theorem that μ satisfies: μ of an LFT on a norm-bounded structured set achieves its maximum on the unitary elements of this set. This is a generalization of the ordinary maximum modulus theorem for rational functions of a complex variable. We begin by stating a well known result from complex analysis namely that the roots of a polynomial are continuous functions of the coefficients of the polynomial.

Lemma 6.1 *Let $f(z) = \sum_{i=0}^n a_i z^i$ be an n ’th order polynomial, $a_n \neq 0$. Let $\bar{z}_1, \bar{z}_2, \dots, \bar{z}_n$ be the roots of f . For any $\epsilon > 0$ and any integer $m > 0$, there exists a $\delta_{m,\epsilon} > 0$ such that if $g(z)$, defined by*

$$g(z) = \sum_{i=0}^m b_i z^i$$

has coefficients $b_i \in \mathbf{C}$ which satisfy $|b_i| < \delta_{m,\epsilon}$, then there are n roots of $f + g$, labeled $\tilde{z}_1, \tilde{z}_2, \dots, \tilde{z}_n$ that satisfy $|\bar{z}_i - \tilde{z}_i| < \epsilon$.

Next, we shift our attention to polynomials in several dimensions, that is, polynomials taking $\mathbf{C}^k \rightarrow \mathbf{C}$. If $z \in \mathbf{C}^k$, we let $\|z\|_\infty := \max_{i \leq k} |z_i|$. For $p: \mathbf{C}^k \rightarrow \mathbf{C}$, a polynomial, define β_p as

$$\beta_p = \min \{ \|z\|_\infty : p(z) = 0 \} \tag{6.1}$$

In other words, β_p is the norm of the minimum norm roots of the polynomial. The next two lemmas are from Doyle, 1982. The first concerns minimum norm roots and is a direct consequence of Lemma 6.1. The second provides the essential argument of the maximum modulus theorem for μ .

Lemma 6.2 *Let p be a polynomial from $\mathbf{C}^k \rightarrow \mathbf{C}$. Define β_p via (6.1). Then there exists a $z \in \mathbf{C}^k$ such that $|z_i| = \beta_p$ for each i , and $p(z) = 0$.*

Sketch of proof: A proof is given in Doyle, 1982. The main idea is as follows: let $\bar{z} \in \mathbf{C}^k$ be a root of p with $\beta_p = \|\bar{z}\|_\infty$. If all of the coordinates of \bar{z} satisfy $|\bar{z}_i| = \beta_p$, then stop. Otherwise, take one of the coordinates of \bar{z} , say \bar{z}_1 whose magnitude is less than β_p . Consider the polynomial $q(z_1) := p(z_1, \bar{z}_2, \dots, \bar{z}_k)$. This has a root at \bar{z}_1 , and $|\bar{z}_1| < \beta_p$. If this is a nontrivial polynomial, then, by slightly reducing (in magnitude) all of the \bar{z}_i , $i \geq 2$, the coefficients of the polynomial change slightly, and it has a root very close to \bar{z}_1 . This implies that p has a root $\tilde{z} \in \mathbf{C}^k$ such that $\|\tilde{z}\|_\infty < \beta_p$, which contradicts the definition. On the other hand, if the polynomial $q \equiv 0$, then the variable z_1 does not matter, and we can repeat the argument on a different coordinate, say z_2 , that satisfies $|\bar{z}_2| < \beta_p$. ‡

Lemma 6.3 *Let $\Delta \subset \mathbf{C}^{n \times n}$ be a given block structure, and let \mathbf{Q} be defined as in section 3. If $M \in \mathbf{C}^{n \times n}$ has $\mu_\Delta(M) = 1$, then there is a $Q \in \mathbf{Q}$ such that $\det(I - MQ) = 0$.*

Proof: Since $\mu_\Delta(M) = 1$, there is a $\hat{\Delta} \in \Delta$ with $\bar{\sigma}(\hat{\Delta}) = 1$ and $\det(I - M\hat{\Delta}) = 0$. Also, for any $\Delta \in \Delta$ with $\bar{\sigma}(\Delta) < 1$, the matrix $I - M\Delta$ is nonsingular.

Do a singular value decomposition on each block that makes up $\hat{\Delta}$. This gives $U, V \in \mathbf{Q}$, and a diagonal $\hat{\Sigma} \in \Delta$, such that

$$\det(I + MU\hat{\Sigma}V^*) = 0$$

Since $\hat{\Sigma} \in \Delta$ is diagonal, it appears as

$$\hat{\Sigma} = \text{diag}[\hat{\delta}_1 I_{r_1}, \dots, \hat{\delta}_S I_{r_S}, \hat{\alpha}_1, \dots, \hat{\alpha}_w]$$

for some nonnegative real numbers $\hat{\delta}_i$ and $\hat{\alpha}_j$, and $w = \sum_{j=1}^F m_j$ (recall that the j 'th full block is $m_j \times m_j$, hence each full block contributes m_j of the α 's). With $\bar{\sigma}(\hat{\Delta}) = 1$, at least one of the $\hat{\delta}_i$ or $\hat{\alpha}_j$ is 1.

Consider $S + w$ complex **variables**, z_1, \dots, z_{S+w} . Define a variable Σ by

$$\Sigma = \text{diag}[z_1 I_{r_1}, \dots, z_S I_{r_S}, z_{S+1}, \dots, z_{S+w}]$$

Then $\det(I + MU\Sigma V^*)$ is a **polynomial** on \mathbf{C}^{S+w} , since the determinant involves only multiplications and additions of its argument. Since $\mu_\Delta(M) = 1$, a minimum norm (using $\|\cdot\|_\infty$ on \mathbf{C}^{S+w} , as above) root of this polynomial has norm equal to 1. Let $\bar{\Sigma}$ be the particular minimizing root with all components of equal magnitude, namely 1. Then we can write $\bar{\Sigma} = \Phi$ for some $\Phi \in \mathbf{Q}$. This gives

$$\det(I + MU\Phi V^*) = 0.$$

Defining $Q := U\Phi V^*$ completes the proof. ‡

The next theorem from (Doyle, 1982) follows immediately from Lemma 6.3 and the facts that $Q \in \mathbf{Q}$ implies $\rho(QM) \leq \mu_{\Delta}(M)$, and $\det(I - MQ) = 0$ implies that $\rho(QM) \geq 1$.

Theorem 6.4 $\max_{Q \in \mathbf{Q}} \rho(QM) = \max_{\Delta \in \mathbf{B}_{\Delta}} \rho(\Delta M) = \mu_{\Delta}(M)$

Hence the lower bound given for μ in equation (3.10) is actually not just a bound, but an equality.

To motivate the main result of the section, recall the general setup for the linear fractional transformation $\mathcal{S}(M, \Delta)$. Suppose $M \in \mathbf{C}^{(n_1+n_2) \times (n_1+n_2)}$ is given. We partition it in the obvious way

$$M = \begin{bmatrix} M_{11} & M_{12} \\ M_{21} & M_{22} \end{bmatrix} \quad (6.2)$$

with $M_{ij} \in \mathbf{C}^{n_i \times n_j}$. Let $\Delta_1 \subset \mathbf{C}^{n_1 \times n_1}$ and $\Delta_2 \subset \mathbf{C}^{n_2 \times n_2}$ be two block structures and define $\mathbf{B}_1, \mathbf{B}_2, \mathbf{Q}_1$, and \mathbf{Q}_2 correspondingly.

The maximum modulus theorem from (Packard and Balsamo, 1988) is:

Theorem 6.5 *Let M be given as in (6.2), along with two block structures Δ_1 and Δ_2 . Suppose that $\mu_2(M_{22}) < 1$. Then*

$$\max_{Q_2 \in \mathbf{Q}_2} \mu_1(\mathcal{S}(M, Q_2)) = \max_{\Delta_2 \in \mathbf{B}_2} \mu_1(\mathcal{S}(M, \Delta_2)). \quad (6.3)$$

Proof: A detailed proof can be found in the reference. The main idea is as follows: suppose (by an appropriate scaling) that the maximum on the right hand side of equation (6.3) is 1. Then, since $\mu_2(M_{22}) < 1$, it is possible to show that $\mu_{\Delta}(M) = 1$. Using Lemma 6.3, construct matrices Q_1 and Q_2 such that $I - M \text{diag}[Q_1, Q_2]$ is singular. Again, use the fact that $\mu_2(M_{22}) < 1$ to conclude that $I - \mathcal{S}(M, Q_2) Q_1$ is singular. This shows that $\mu_1(\mathcal{S}(M, Q_2)) \geq 1$, completing the argument. \sharp

Remark 6.6 This is similar to a result in (Boyd and Desoer, 1985): that for functions $H(z)$ analytic on the disk, the function $\mu(H(z))$ achieves its maximum on the boundary: $\max_{|z| \leq 1} \mu(H(z)) = \max_{|z|=1} \mu(H(z))$. It is possible to use their result to derive Theorem 6.5 and vice versa.

It is instructive to see how Theorem 6.4 can be obtained as a special case of Theorem 6.5. Let $\Delta \subset \mathbf{C}^{n \times n}$ be a given block structure, with associated sets \mathbf{B}_{Δ} and \mathbf{Q} . Define $\Delta_1 := \{\delta I_n : \delta \in \mathbf{C}\}$, and for each $M \in \mathbf{C}^{n \times n}$, define \bar{M} as

$$\bar{M} := \begin{bmatrix} 0 & M \\ I_n & 0 \end{bmatrix}$$

By Theorem 6.5, and noting that $\mu_1(\cdot) = \rho(\cdot)$, we have

$$\max_{Q \in \mathbf{Q}} \rho(MQ) = \max_{Q \in \mathbf{Q}} \mu_1(\mathcal{S}(\bar{M}, Q)) = \max_{\Delta \in \mathbf{B}_{\Delta}} \mu_1(\mathcal{S}(\bar{M}, \Delta)) = \max_{\Delta \in \mathbf{B}_{\Delta}} \rho(M\Delta) = \mu_{\Delta}(M) \quad (6.4)$$

This is exactly Theorem 6.4.

7 Lower bound power algorithm

This section presents an iterative algorithm to compute lower bounds for the structured singular value. The algorithm resembles a mixture of power methods for eigenvalues and singular values, which is not surprising, since the structured singular value can be viewed as a generalization of both. If the algorithm converges, a lower bound for μ results. We prove that μ is always an equilibrium point of the algorithm.

In (Fan and Tits, 1986) the calculation of μ is reformulated as a smooth optimization problem. As with all of the known exact expressions for μ , the function to be maximized has local maximums which are not global, so in general the method yields only lower bounds for μ . Similar comments can be made for the ideas in (Doyle, 1982) and (Helton, 1988), as well as the algorithm in this section. The contribution here is yet another lower bound algorithm to aid in the analysis of robustness of systems with structured uncertainty, along with a deeper conceptual understanding of the structured singular value.

We begin by noting that both the functions $r : \mathbf{B}_\Delta \rightarrow \mathbf{R}$, defined by $r(\Delta) := \rho(\Delta M)$ and $\tilde{r} : \mathbf{Q} \rightarrow \mathbf{R}$, defined by $\tilde{r}(Q) := \rho(QM)$ have local maximums which are not global. Note, though, that the function \tilde{r} is a restriction of r , and it is possible to construct examples where a point $Q \in \mathbf{Q}$ is a local maximum of \tilde{r} , but not a local maximum of r . Such a point definitely does not correspond to the maximizer that gives $\mu_\Delta(M)$, and so we will not consider the corresponding lower bound from such points as acceptable. Rather, acceptable lower bounds will correspond to points $Q \in \mathbf{Q}$ which are *local maximums of the function r* .

Roughly speaking, this section develops an iterative algorithm which ultimately generates a point $Q \in \mathbf{Q}$ that is a local maximum of the function r . In general, these are a proper subset of the local maximums of the function \tilde{r} , though the global maximums over the two sets are the same. Some of the preliminary results are generalizations of those found in (Fan and Tits, 1986) and (Daniel, Kouvaritakis, et al, 1986)

We will be interested in local maximums of the function $r(\Delta) = \rho(\Delta M)$, therefore we begin with some facts from perturbation theory, which assist in characterizing local maximums.

7.1 Matrix Facts

In this section, we collect a few useful facts.

Suppose $W : \mathbf{R} \rightarrow \mathbf{C}^{n \times n}$ is an analytic function of the real parameter t . If λ_o is an eigenvalue of $W_o := W(0)$ of multiplicity one, then for some open interval containing 0, this eigenvalue is an analytic function of t , as are the eigenvectors associated with it. That is, suppose there are $x_o, y_o \in \mathbf{C}^n$, satisfying $y_o^* x_o = 1$, $W_o x_o = \lambda_o x_o$, and $y_o^* W = \lambda_o y_o^*$. Then there is an $\epsilon > 0$ and analytic functions $x : (-\epsilon, \epsilon) \rightarrow \mathbf{C}^n$, $y : (-\epsilon, \epsilon) \rightarrow \mathbf{C}^n$, and $\lambda : (-\epsilon, \epsilon) \rightarrow \mathbf{C}$, such that $x(0) = x_o$, $y(0) = y_o$, $\lambda(0) = \lambda_o$ and for all $t \in (-\epsilon, \epsilon)$

$$\begin{aligned} y^* x &= 1 \\ W x &= \lambda x \\ y^* W &= \lambda y^*. \end{aligned} \tag{7.1}$$

This follows from (Kato, 1982). We can then differentiate and obtain $\dot{\lambda}(0) = y_o^* \dot{W}(0) x_o$.

The next two lemmas follow from elementary linear algebra. They will be used in the main theorem of the next section.

Lemma 7.1 *Let $y, x \in \mathbf{C}^n$ with $y \neq 0$ and $x \neq 0$. There exists $d \in \mathbf{R}$, $d > 0$, such that $\frac{1}{\sqrt{d}}y = \sqrt{d}x$ if and only if $\operatorname{Re}(y^*Gx) \leq 0$ for every $G \in \mathbf{C}^{n \times n}$ satisfying $G + G^* \leq 0$.*

Lemma 7.2 *Let x and y be two nonzero vectors in \mathbf{C}^n . Then there exists a Hermitian, positive definite $D \in \mathbf{C}^{n \times n}$, such that $D^{\frac{1}{2}}x = D^{-\frac{1}{2}}y$ if and only if $\operatorname{Re}(gy^*x) \leq 0$ for every $g \in \mathbf{C}$ with $g + \bar{g} \leq 0$.*

The condition in Lemma 7.2 on y^*x involving $g \in \mathbf{C}$ is equivalent to y^*x being real and positive. We have chosen to write it in the form above so that it is a natural analog to Lemma 7.1 and is stated exactly as it will be applied in Theorem 7.3 of the next section.

7.2 Eigenvector characterization of local maximums

Consider the function $r: \mathbf{B}_\Delta \rightarrow \mathbf{R}$, defined by $r(\Delta) = \rho(\Delta M)$. Recall that $\mu_\Delta(M) = \max_{\Delta \in \mathbf{B}_\Delta} r(\Delta)$, and that the *global maximum occurs on the subset $\mathbf{Q} \subset \mathbf{B}_\Delta$* . In this section, we characterize the occurrence of a *local maximum* of r at $\Delta = I \in \mathbf{Q} \subset \mathbf{B}_\Delta$, in terms of the eigenvectors of M . We begin with some notation.

Let x and y be nonzero right and left eigenvectors of M , associated with an eigenvalue λ : $Mx = \lambda x$ and $y^*M = \lambda y^*$. Partition x and y compatibly with the block structure Δ ,

$$x = \begin{bmatrix} x_{r_1} \\ x_{r_2} \\ \vdots \\ x_{r_S} \\ x_{m_1} \\ x_{m_2} \\ \vdots \\ x_{m_F} \end{bmatrix}, \quad y = \begin{bmatrix} y_{r_1} \\ y_{r_2} \\ \vdots \\ y_{r_S} \\ y_{m_1} \\ y_{m_2} \\ \vdots \\ y_{m_F} \end{bmatrix} \quad (7.2)$$

where $x_{r_i}, y_{r_i} \in \mathbf{C}^{r_i}$ and $x_{m_j}, y_{m_j} \in \mathbf{C}^{m_j}$ for each i and j . We call these the “block components” of x and y , and for technical reasons, we define a nondegeneracy condition: x and y are *nondegenerate* if for every i , $y_{r_i}^* x_{r_i} \neq 0$, and for each j , $x_{m_j} \neq 0, y_{m_j} \neq 0$. We will also assume that $\rho(M) = \lambda_o > 0$ is a *distinct* eigenvalue of M .

The condition that $\rho(M) = \lambda_o > 0$ is without loss of generality, because Δ can always be used to enforce this (for any ϕ , $e^{j\phi} \Delta = \Delta$). The conditions of nondegeneracy and λ_o distinct are not so easily dispensed with and there are basically two approaches to deal with them. The first would be to argue that they are generic conditions and thus unlikely to cause problems in practice. A far more satisfactory solution is to generalize the theorems and proofs in this section to remove them.

In fact, this can be done, but not without substantial additional technical complication. Since the results in this subsection are presented primarily to give insight into the power algorithms to be presented in the next subsection, these additional technicalities have been foregone in favor of a simpler development.

Theorem 7.3 *Let $M \in \mathbf{C}^{n \times n}$ be given, and suppose $\lambda_o > 0$ is a distinct eigenvalue of M , with nondegenerate right and left eigenvectors x and y . Suppose that $\rho(M) = \lambda_o$. If the function $r : \mathbf{B}_\Delta \rightarrow \mathbf{R}$ defined by $r(\Delta) = \rho(\Delta M)$ has a local maximum (with respect to the set \mathbf{B}_Δ) at $\Delta = I$, then there exists a $D \in \mathbf{D}$ such that $D^{-\frac{1}{2}}y = D^{\frac{1}{2}}x$.*

Proof: Let $G \in \mathbf{\Delta}$ with $G + G^* \leq 0$ so that G has the form

$$\text{diag}[g_1 I_{r_1}, \dots, g_S I_{r_S}, G_1, \dots, G_F] \quad (7.3)$$

where $\text{Re}(g_i) \leq 0$, and $G_j + G_j^* \leq 0$ for all i and j and $e^{Gt} \in \mathbf{B}_\Delta$ for all $t \geq 0$ with $e^{Gt} = I$ for $t = 0$. Define a matrix function $W : \mathbf{R} \rightarrow \mathbf{C}^{n \times n}$ by $W(t) := e^{Gt}M$. Note that at $t = 0$, λ_o is a simple eigenvalue of $W(0)$, with x and y the right and left eigenvectors. For some nonempty interval containing 0, this eigenvalue is always simple, and hence there is an analytic function of the real variable t , $\lambda(t)$, defined on that interval, such that $\lambda(t)$ is an eigenvalue of $W(t)$ for all t and $\lambda(0) = \lambda_o$. It is easy to calculate $\dot{\lambda}(0)$, namely

$$\dot{\lambda}(0) = y^* \dot{W}(0)x = \lambda_o y^* G x \quad (7.4)$$

By hypothesis, $\lambda_o > 0$, $\rho(M) = \lambda_o$ and the function $\rho(\Delta M)$ has a local maximum (with respect to \mathbf{B}_Δ) at $\Delta = I$. Therefore

$$\text{Re} \left(\left. \frac{d}{dt} \lambda(t) \right|_{t=0} \right) \leq 0 \quad (7.5)$$

which says that the magnitude of λ must be nonincreasing at $t = 0$. Using the ‘‘block notation’’ of (7.2) and substituting (7.3) and (7.4) into (7.5) yields

$$\text{Re} \left(\sum_{i=1}^S g_i y_{r_i}^* x_{r_i} + \sum_{j=1}^F y_{m_j}^* G_j x_{m_j} \right) \leq 0. \quad (7.6)$$

This must hold for *arbitrary* $G \in \mathbf{\Delta}$ satisfying $G + G^* \leq 0$. Applying Lemmas 7.1 and 7.2 we conclude that for each i , there is a $D_i = D_i^* \in \mathbf{C}^{n \times n}$, $D_i > 0$ such that $D_i^{-\frac{1}{2}} y_{r_i} = D_i^{\frac{1}{2}} x_{r_i}$, and for each j , there is a $d_j \in \mathbf{R}$, $d_j > 0$ such that $\frac{1}{\sqrt{d_j}} y_{m_j} = \sqrt{d_j} x_{m_j}$. Arranging all of these D_i ’s and d_j ’s into one block diagonal D completes the proof. \sharp

Remark 7.4 Note that assuming λ_o is distinct assures differentiability, (Kato, 1982). Since λ_o is a solution of $\max_{\Delta \in \mathbf{B}_\Delta} \max_i |\lambda_i(\Delta M)|$, it is likely that at the maximum it will be distinct. In any case, if λ_o is not distinct, it can still be shown to be differentiable at a local maximum, and the rest of the proof remains. Unfortunately, this proof of differentiability is tedious and technical, and for this reason has been omitted.

Theorem 7.5 Let $Q_o \in \mathbf{Q}$ achieve the global optimum for the problem $\max_{Q \in \mathbf{Q}} \rho(QM)$. Suppose that the eigenvalue associated with $\rho(Q_oM)$ is distinct, real and positive, and hence equal to $\mu = \mu_{\Delta}(M)$. If x and y are nondegenerate right and left eigenvectors of the eigenvalue μ , then there exists a $D \in \mathbf{D}$, and $\xi \in \mathbf{C}^n$, $\|\xi\| = 1$ such that

$$\begin{aligned} Q_o D^{\frac{1}{2}} M D^{-\frac{1}{2}} \xi &= \mu \xi \\ \xi^* Q_o D^{\frac{1}{2}} M D^{-\frac{1}{2}} &= \mu \xi^*. \end{aligned} \quad (7.7)$$

Proof: By Theorem 6.4, any global maximizer of $\max_{Q \in \mathbf{Q}} \rho(QM)$, is also a maximizer of $\max_{\Delta \in \mathbf{B}_{\Delta}} \rho(\Delta M)$.

Define $\tilde{M} := Q_o M$, then $\Delta = I$ is a local (in fact global) maximizer for $\max_{\Delta \in \mathbf{B}_{\Delta}} \rho(\Delta \tilde{M})$.

Apply Theorem 7.3 to the matrix \tilde{M} and define $\xi = D^{\frac{1}{2}} x = D^{-\frac{1}{2}} y$ to prove the theorem. $\#$

Remark 7.6 This result was first shown in (Fan and Tits, 1986) for the case of $S = 0$. It is also similar to the ‘‘principal direction alignment’’ ideas in (Daniel, Kouvaritakis, et al, 1986). Theorem 7.5 is more general, though, since it handles repeated scalar blocks as well as full blocks.

Remark 7.7 This theorem is **not true** if we consider *local maximums that are not global* of the function $\tilde{r}: \mathbf{Q} \rightarrow \mathbf{R}$ defined as $\tilde{r}(Q) := \rho(QM)$.

Remark 7.8 Any real number $\beta > 0$ satisfying

$$\begin{aligned} Q D^{\frac{1}{2}} M D^{-\frac{1}{2}} \xi &= \beta \xi \\ \xi^* Q D^{\frac{1}{2}} M D^{-\frac{1}{2}} &= \beta \xi^* \end{aligned} \quad (7.8)$$

for some $Q \in \mathbf{Q}$, $D \in \mathbf{D}$ and nonzero $\xi \in \mathbf{C}^n$ is a lower bound for $\mu_{\Delta}(M)$. This follows because $I - \frac{1}{\beta} QM$ is a singular matrix.

7.3 Lower bound power algorithm

In this section, we propose an iterative algorithm (reminiscent of the power algorithm for spectral radius) to find solutions to the equations (7.7), and therefore get lower bounds for μ .

Rewriting (7.7), and changing notation a bit, we want to find a $Q \in \mathbf{Q}$, $D \in \mathbf{D}$, $\beta > 0$, and $\xi \in \mathbf{C}^n$ with $\|\xi\| = 1$ such that

$$\begin{aligned} Q D^{\frac{1}{2}} M D^{-\frac{1}{2}} \xi &= \beta \xi \\ D^{-\frac{1}{2}} M^* D^{\frac{1}{2}} Q^* \xi &= \beta \xi. \end{aligned}$$

These two constraint equations can be rewritten as

$$\begin{aligned} M \left(D^{-\frac{1}{2}} \xi \right) &= \beta \left(D^{-\frac{1}{2}} Q^* \xi \right) \\ M^* \left(D^{\frac{1}{2}} Q^* \xi \right) &= \beta \left(D^{\frac{1}{2}} \xi \right). \end{aligned}$$

For a given D, Q , and ξ , define vectors a, b, z , and w by

$$\begin{aligned} b &:= D^{-\frac{1}{2}} \xi \quad , \quad a := D^{-\frac{1}{2}} Q^* \xi \\ z &:= D^{\frac{1}{2}} Q^* \xi \quad , \quad w := D^{\frac{1}{2}} \xi \end{aligned} \quad (7.9)$$

With this definition, we have $Mb = \beta a$ and $M^*z = \beta w$. We can eliminate ξ from (7.9) to get

$$\begin{aligned} b &= Qa = D^{-1}w \\ z &= Da = Q^*w \end{aligned} \tag{7.10}$$

Since the unknowns Q and D generally may have high dimension, we would like to write the four relationships from equation (7.10) in a manner that does not involve the matrices Q and D . With a few technical conditions, this can be done. In order to simplify the upcoming formulas, we will consider a block structure with $S = 1, F = 1$ (by duplicating the appropriate formulas for additional blocks, whether they are repeated scalar blocks or full blocks, it is straightforward to extend the algorithm to more general structures). Hence the sets \mathbf{D} and \mathbf{Q} are

$$\mathbf{D} = \{\text{diag}[D_1, d_2 I_{m_1}] : D_1 \in \mathbf{C}^{r_1 \times r_1}, D_1 = D_1^* > 0, d_2 > 0\} \tag{7.11}$$

$$\mathbf{Q} = \{\text{diag}[q_1 I_{r_1}, Q_2] : \bar{q}_1 q_1 = 1, Q_2 \in \mathbf{C}^{m_1 \times m_1}, Q_2^* Q_2 = I_{m_1}\}. \tag{7.12}$$

With respect to this, we will partition the vectors accordingly, so $z = \begin{bmatrix} z_1 \\ z_2 \end{bmatrix}$, where $z_1 \in \mathbf{C}^{r_1}$ and $z_2 \in \mathbf{C}^{m_1}$, and likewise for the other vectors.

Lemma 7.9 *Let r_1 and m_1 be positive integers. Let $z_1, w_1, b_1, a_1 \in \mathbf{C}^{r_1}$ and $z_2, w_2, b_2, a_2 \in \mathbf{C}^{m_1}$ be nonzero vectors with $a_1^* w_1 \neq 0$. Then, there exists a $D \in \mathbf{D}$ and $Q \in \mathbf{Q}$ such that*

$$\begin{aligned} b &= Qa \quad , \quad z = Q^*w \\ z &= Da \quad , \quad b = D^{-1}w \end{aligned}$$

if and only if

$$\begin{aligned} z_1 &= \frac{w_1^* a_1}{|w_1^* a_1|} w_1 \quad , \quad z_2 = \frac{\|w_2\|}{\|a_2\|} a_2 \\ b_1 &= \frac{a_1^* w_1}{|a_1^* w_1|} a_1 \quad , \quad b_2 = \frac{\|a_2\|}{\|w_2\|} w_2. \end{aligned}$$

Proof:

→ The relations for z_2 and b_2 follow by direct substitution. For z_1 and b_1 , it is easiest to define an auxiliary variable $\zeta := D^{\frac{1}{2}}b$, and then verify via substitutions.

← Let $q_1 = \frac{a_1^* w_1}{|a_1^* w_1|}$, since this is well defined. Likewise, choose $d_2 = \frac{\|w_2\|}{\|a_2\|}$. By assumption, d_2 is well defined, and nonzero. Since $\|w_2\| = \|z_2\|$, let Q_2 be any unitary matrix that takes w_2 into z_2 . The matrix Q_2 also rotates b_2 into a_2 ,

$$Q_2 b_2 = \frac{1}{d_2} Q_2 w_2 = \frac{1}{d_2} z_2 = a_2.$$

Next, we calculate $a_1^* z_1 = |a_1^* w_1|$, which is nonzero by assumption; hence Lemma 7.2 yields a Hermitian, positive definite D_1 such that $D_1 a_1 = z_1$. As we hope, D_1 takes b_1 into w_1 too,

$$D_1 b_1 = q_1 D_1 a_1 = q_1 z_1 = w_1.$$

Defining D and Q in the obvious manner completes the proof. ‡

We are now prepared for the main theorem.

Theorem 7.10 *Let $M \in \mathbf{C}^{n \times n}$ be given, and let Δ be the two block ($S = 1, F = 1$) structure defined above, with block sizes r_1 and m_1 , where $r_1 + m_1 = n$. Suppose $\beta > 0$ is given. Then there exists $Q \in \mathbf{Q}$, $D \in \mathbf{D}$, $\xi = \begin{bmatrix} \xi_1 \\ \xi_2 \end{bmatrix} \in \mathbf{C}^n$, $\|\xi\| = 1$, $\xi_1 \neq 0$, $\xi_2 \neq 0$ with*

$$\begin{aligned} QD^{\frac{1}{2}}MD^{-\frac{1}{2}}\xi &= \beta\xi \\ \xi^*QD^{\frac{1}{2}}MD^{-\frac{1}{2}} &= \beta\xi^* \end{aligned} \quad (7.13)$$

if and only if there exists nonzero vectors $z_1, w_1, b_1, a_1 \in \mathbf{C}^{r_1}$ and $z_2, w_2, b_2, a_2 \in \mathbf{C}^{m_1}$ with $a_1^*w_1 \neq 0$ and

$$\begin{aligned} \beta a &= Mb \\ z_1 &= \frac{w_1^* a_1}{|w_1^* a_1|} w_1 \quad , \quad z_2 = \frac{\|w_2\|}{\|a_2\|} a_2 \\ \beta w &= M^* z \\ b_1 &= \frac{a_1^* w_1}{|a_1^* w_1|} a_1 \quad , \quad b_2 = \frac{\|a_2\|}{\|w_2\|} w_2. \end{aligned} \quad (7.14)$$

Remark: In order to find decompositions using the representation that this theorem allows (equation (7.14) — free of Q 's and D 's), we can restrict ourselves to unit vectors a, b, z, w . Why? Suppose there are nonzero vectors satisfying (7.14). Examining the equations, it is clear that scaling z and w by some $\alpha \neq 0$ and scaling b and a by some $\gamma \neq 0$ does not affect any of the equalities in (7.14). Moreover, the equalities in (7.14) always imply that $\|z\| = \|w\|$, and $\|a\| = \|b\|$, so by proper scaling, all the vectors would be unit norm.

In the above theorem, we have purposefully written the conditions (7.14) in a manner that suggests attempting to find a solution in an iterative fashion. In particular, for $i = 1, 2$, let vectors $a_{i_k}, b_{i_k}, z_{i_k}$, and w_{i_k} , and positive scalars $\tilde{\beta}_k, \hat{\beta}_k$ evolve as

$$\begin{aligned} \tilde{\beta}_{k+1} a_{k+1} &= Mb_k \\ z_{1_{k+1}} &= \frac{w_{1_k}^* a_{1_{k+1}}}{|w_{1_k}^* a_{1_{k+1}}|} w_{1_k} \quad , \quad z_{2_{k+1}} = \frac{\|w_{2_k}\|}{\|a_{2_{k+1}}\|} a_{2_{k+1}} \\ \hat{\beta}_{k+1} w_{k+1} &= M^* z_{k+1} \\ b_{1_{k+1}} &= \frac{a_{1_{k+1}}^* w_{1_{k+1}}}{|a_{1_{k+1}}^* w_{1_{k+1}}|} a_{1_{k+1}} \quad , \quad b_{2_{k+1}} = \frac{\|a_{2_{k+1}}\|}{\|w_{2_{k+1}}\|} w_{2_{k+1}} \end{aligned} \quad (7.15)$$

where the values of $\tilde{\beta}_{k+1}$ and $\hat{\beta}_{k+1}$ are chosen > 0 , so that $\|a_{k+1}\| = \|w_{k+1}\| = 1$.

Note also that if the initial b and w vectors that start the iteration are unit vectors, then at every step, all vectors, a, b, z , and w will be unit length.

Remarks:

7.a Potential problems within the iteration are:

- $Mb_k = 0$ or $M^*z_k = 0$, then a_{k+1} or w_{k+1} is not well defined.
- $a_{1_k}^* w_{1_k} = 0$, then the vectors $z_{1_{k+1}}$ and/or $b_{1_{k+1}}$ are not well defined.
- Either $\|w_{2_k}\| = 0$ or $\|a_{2_k}\| = 0$, making b_{2_k} and/or z_{2_k} not well defined.

If any of these conditions occur, then one possibility is to restart the algorithm at a different initial condition (ie., a new $b_{1_0}, b_{2_0}, w_{1_0}$ and w_{2_0}). A more sophisticated approach is to examine the above conditions and recognize that a sensible iteration can still be defined even if these conditions occur. Algorithms have been developed along these lines and will be discussed elsewhere.

7.b If the iteration does converge to an equilibrium point, then the β values must be equal, that is $\tilde{\beta} = \hat{\beta}$. This is easy to see: suppose the equations in (7.14) are satisfied (convergence of the algorithm in (7.15)), but the β associated with b and a is $\tilde{\beta}$ and the β associated with z and w is $\hat{\beta}$. The converged equations imply that there exists a $Q \in \mathbf{Q}$ and $D \in \mathbf{D}$ such that $QD^{\frac{1}{2}}MD^{-\frac{1}{2}}(D^{\frac{1}{2}}b) = \tilde{\beta}(D^{\frac{1}{2}}b)$ and $(QD^{\frac{1}{2}}MD^{-\frac{1}{2}})^*(D^{\frac{1}{2}}b) = \hat{\beta}(D^{\frac{1}{2}}b)$. Since the β 's are real, they must be equal. Hence, when verifying convergence of the algorithm, it is necessary to begin checking the convergence of the vectors *only after* the $\tilde{\beta}_k$ and $\hat{\beta}_k$ values are nearly equal. This saves some computations early in the iteration.

7.c

- If there were only the first block, which is a repeated scalar block, the iteration would be a power iteration for the largest (in magnitude) eigenvalue of the matrix M . Since μ for 1 repeated scalar block is the spectral radius, the algorithm we have proposed reduces to a valid algorithm in the special case of 1 repeated scalar block.
- If there were only the second block, which is a full block, the iteration becomes an eigenvalue power algorithm for M^*M , hence it will give the largest singular value of M . Again, with respect to this specific block structure, this is what we want.

Hence, the iteration we have proposed is a mix of two separate, well understood iterations, both of which converge to the largest eigenvalue/singular value. We might hope that this algorithm will converge to the largest β for which the equations in (7.8) are solved, which by Theorem 7.5 is equal to $\mu_{\Delta}(M)$. Unfortunately, this is not always the case.

Extensive computational experience, (Balas, Doyle, et al, 1991) and (Packard, Fan, et al, 1988), has led to the following conclusions:

1. The algorithm works well in practice, and versions of it have been used very extensively in universities and industry. It appears to have roughly order n^2 growth rates for computation as a function of problem size. The main difficulty is that it occasionally doesn't converge or converges to a value of β which is not μ .
2. The difficulties described in 7.a above do not *seem* to occur in practice, however there are matrices whose optimally scaled eigenvector block components (eq. 7.2) do not satisfy the "nonzero" block conditions described at the beginning of section 7.2. This type of situation will lead to the difficulties mentioned. In any event, while it is easy to construct matrices where these problems happen, running the algorithm on frequency responses of actual closed loop systems has not been a problem.

3. Limit cycles can occur, and seem to occur more often when there are large repeated scalar blocks. Unlike an equilibrium point, the presence of a stable limit cycle does not immediately give rise to a lower bound for μ .
4. In general, there are several stable equilibrium points, with different values of β . This is in contrast with the conventional power algorithms for ρ and $\bar{\sigma}$, where only the largest ones are stable. It is even possible that the algorithm converges to a value of β which is smaller than $\rho(M)$.
5. It is possible to refine the power algorithm to guarantee convergence to some local maximum, but at the expense of greater computation time. We are currently researching algorithms that give favorable tradeoffs between convergence properties and running times.

8 Relating μ and $\inf_{D \in \mathbf{D}} \bar{\sigma} \left(D^{\frac{1}{2}} M D^{-\frac{1}{2}} \right)$

The purpose of this section is to study the relationship between $\mu_{\Delta}(M)$ and the upper bound. The two-step strategy we take first involves characterizing the optimality conditions for the upper bound, and then determining under what situations these optimality conditions imply anything about the existence of a block structured perturbation matrix Δ satisfying $\det(I - M\Delta) = 0$.

8.1 Optimality Conditions for $\inf_{D \in \mathbf{D}} \bar{\sigma} \left(D^{\frac{1}{2}} M D^{-\frac{1}{2}} \right)$

We want to characterize when $\bar{\sigma}(M) = \inf_{D \in \mathbf{D}} \bar{\sigma} \left(D^{\frac{1}{2}} M D^{-\frac{1}{2}} \right)$, that is, when $D := I$ is optimal. Begin with $M \in \mathbf{C}^{n \times n}$, and let its singular value decomposition be

$$M = \sigma_1 U V^* + U_2 \Sigma_2 V_2^*, \quad (8.1)$$

where $\sigma_1 > 0$ is the maximum singular value of M and has multiplicity r ; $U, V \in \mathbf{C}^{n \times r}$; $U_2, V_2 \in \mathbf{C}^{n \times (n-r)}$; $U^* U = V^* V = I_r$; $U_2^* U_2 = V_2^* V_2 = I_{n-r}$; $U^* U_2 = 0$; $V^* V_2 = 0$; and $\Sigma_2 \in \mathbf{R}^{(n-r) \times (n-r)}$ is nonnegative and diagonal with $\sigma_1 I_{n-r} - \Sigma_2 > 0$.

We need some additional notation, in particular

$$\mathbf{Z} := \left\{ D - \tilde{D} : D, \tilde{D} \in \mathbf{D} \right\} \quad (8.2)$$

Note that the elements of \mathbf{Z} are not invertible, and in general are of the form (since $d_{S+F} \equiv 1$)

$$\text{diag} [Z_1, \dots, Z_S, z_{S+1} I_{m_1}, \dots, z_{S+F-1} I_{m_{F-1}}, 0_{m_F}]$$

where for each $i \leq S$, $Z_i = Z_i^* \in \mathbf{C}^{r_i \times r_i}$, and for $j \leq F-1$, $z_{S+j} \in \mathbf{R}$. Later, we will use the fact that \mathbf{Z} is a real inner product space, with inner product defined by $P, T \in \mathbf{Z}$

$$\langle P, T \rangle := \sum_{i=1}^S \text{trace} (P_i T_i) + \sum_{j=1}^{F-1} p_{S+j} t_{S+j}.$$

For notational purposes, partition U and V compatibly with Δ as

$$U = \begin{bmatrix} A_1 \\ \vdots \\ A_S \\ E_1 \\ \vdots \\ E_F \end{bmatrix} \quad V = \begin{bmatrix} B_1 \\ \vdots \\ B_S \\ H_1 \\ \vdots \\ H_F \end{bmatrix} \quad (8.3)$$

where $A_i, B_i \in \mathbf{C}^{r_i \times r}$, $E_i, H_i \in \mathbf{C}^{m_i \times r}$. With this notation, and a little manipulation, for any $Z \in \mathbf{Z}$, we can write $\lambda_{\min}(U^*ZU - V^*ZV)$ in terms of inner products in \mathbf{Z} ,

$$\lambda_{\min}(U^*ZU - V^*ZV) = \min_{\substack{\eta \in \mathbf{C}^r \\ \|\eta\|=1}} \langle Z, P^\eta \rangle \quad (8.4)$$

where for each $\eta \in \mathbf{C}^r$, $P^\eta \in \mathbf{Z}$ is defined by its block components

$$\begin{aligned} P_i^\eta &:= A_i \eta \eta^* A_i^* - B_i \eta \eta^* B_i^* \\ p_{S+j}^\eta &:= \eta^* (E_j^* E_j - H_j^* H_j) \eta. \end{aligned} \quad (8.5)$$

Let $\nabla_M \subset \mathbf{Z}$ be the set of all such P^η . That is

$$\nabla_M := \left\{ \text{diag} \left[P_1^\eta, \dots, P_S^\eta, p_{S+1}^\eta I_{m_1}, \dots, p_{S+F-1}^\eta I_{m_{F-1}}, 0_{m_F} \right] : P_i^\eta, p_{S+j}^\eta \text{ as in (8.5), } \eta \in \mathbf{C}^r, \|\eta\| = 1 \right\}. \quad (8.6)$$

Although the matrices U and V are not unique, the set ∇_M **does not** depend on their particular choice. For a given $Z \in \mathbf{Z}$, we have

$$\lambda_{\min}(U^*ZU - V^*ZV) = \min_{P \in \nabla_M} \langle Z, P \rangle. \quad (8.7)$$

Hence, it is the set ∇_M that determines whether or not there is a Z such that

$$\lambda_{\min}(U^*ZU - V^*ZV) > 0.$$

Let the convex hull of a set $\mathcal{V} \subset \mathbf{Z}$ be denoted $\text{co}(\mathcal{V})$.

Theorem 8.1 *There exists a $Z \in \mathbf{Z}$ such that $\lambda_{\min}(U^*ZU - V^*ZV) > 0$ if and only if $0 \notin \text{co}(\nabla_M)$.*

Proof This is a consequence of (8.7), and a standard result about convex hulls of sets in inner product spaces, (Luenberger, 1969). \sharp

Now the optimality condition can be derived. In the proof that follows, note that no appeal to differentiability of eigenvalues is necessary, and all of the steps of the proof are elementary linear algebra. The idea for such a simple approach is from (Young, 1992), and (Poolla, 1991).

Theorem 8.2 $\inf_{D \in \mathbf{D}} \bar{\sigma} \left(D^{\frac{1}{2}} M D^{-\frac{1}{2}} \right) = \bar{\sigma}(M)$ if and only if $0 \in \text{co}(\nabla_M)$.

Proof \Rightarrow Suppose that $0 \notin \text{co}(\nabla_M)$. Choose a matrix $Z \in \mathbf{Z}$ such that

$$\lambda_{\min}(U^*ZU - V^*ZV) > 0.$$

Equivalently,

$$\lambda_{\max}(V^*ZV - U^*ZU) < 0.$$

Now, note that for every $\alpha > 0$

$$\begin{bmatrix} V^* \\ V_2^* \end{bmatrix} \left[M^*(I - \alpha Z)M - \sigma_1^2(I - \alpha Z) \right] \begin{bmatrix} V & V_2 \end{bmatrix}$$

is equal to

$$\begin{bmatrix} \sigma_1^2 \alpha (V^*ZV - U^*ZU) & \alpha \sigma_1 (\sigma_1 V^*ZV_2 - U^*ZU_2 \Sigma_2) \\ \alpha \sigma_1 (\sigma_1 V_2^*ZV - \Sigma_2 U_2^*ZU) & \Sigma_2^2 - \sigma_1^2 I + \alpha (\sigma_1^2 V_2^*ZV_2 - \Sigma_2 U_2^*ZU_2 \Sigma_2) \end{bmatrix}$$

Call $T := \sigma_1 (\sigma_1 V^*ZV_2 - U^*ZU_2 \Sigma_2)$, and $L := (\sigma_1^2 V_2^*ZV_2 - \Sigma_2 U_2^*ZU_2 \Sigma_2)$. Using this notation, the matrix in question becomes

$$\begin{bmatrix} \sigma_1^2 \alpha (V^*ZV - U^*ZU) & \alpha T \\ \alpha T^* & \Sigma_2^2 - \sigma_1^2 I + \alpha L \end{bmatrix}.$$

Choose $\alpha > 0$ small enough so that the three conditions

$$\begin{aligned} I - \alpha Z &> 0 \\ \Sigma_2^2 - \sigma_1^2 I + \alpha L &< 0 \\ \sigma_1^2 (V^*ZV - U^*ZU) - \alpha T (\Sigma_2^2 - \sigma_1^2 I + \alpha L)^{-1} T^* &< 0 \end{aligned}$$

are satisfied. This is possible, since $I > 0$, $(V^*ZV - U^*ZU) < 0$, and $\Sigma_2^2 - \sigma_1^2 I < 0$. Using Schur complements, it is clear that for such α , the matrix

$$\begin{bmatrix} \sigma_1^2 \alpha (V^*ZV - U^*ZU) & \alpha T \\ \alpha T^* & \Sigma_2^2 - \sigma_1^2 I + \alpha L \end{bmatrix} < 0$$

This implies that

$$\left[M^*(I - \alpha Z)M - \sigma_1^2(I - \alpha Z) \right] < 0$$

Define $D := I - \alpha Z$, and note that

$$\inf_{D \in \mathbf{D}} \bar{\sigma} \left(D^{\frac{1}{2}} M D^{-\frac{1}{2}} \right) \leq \bar{\sigma} \left(D^{\frac{1}{2}} M D^{-\frac{1}{2}} \right) < \sigma_1 = \bar{\sigma}(M)$$

as desired.

(\Leftarrow) Suppose that $\inf_{D \in \mathbf{D}} \bar{\sigma} \left(D^{\frac{1}{2}} M D^{-\frac{1}{2}} \right) < \bar{\sigma}(M)$. Choose $D \in \mathbf{D}$ such that $\bar{\sigma} \left(D^{\frac{1}{2}} M D^{-\frac{1}{2}} \right) < \bar{\sigma}(M)$. Define $Z \in \mathbf{Z}$ via $Z := I - D$. Note that

$$M^*DM - \sigma_1^2 D = M^*(I - Z)M - \sigma_1^2(I - Z) < 0$$

Hence, for all $\eta \in \mathbf{C}^r$, with $\|\eta\| = 1$, we have

$$\begin{aligned} 0 &> \eta^* V^* [M^*(I - Z)M - \sigma_1^2(I - Z)] V \eta \\ &= \sigma_1^2 [\eta^* U^*(I - Z)U \eta - \eta^* V^*(I - Z)V \eta] \\ &= \sigma_1^2 \eta^* (V^*ZV - U^*ZU) \eta \end{aligned}$$

Hence, this $Z := I - D \in \mathbf{Z}$ satisfies

$$\lambda_{\max}(V^*ZV - U^*ZU) < 0$$

which is equivalent to

$$\lambda_{\min}(U^*ZU - V^*ZV) > 0.$$

By Theorem 8.1, it must be that $0 \notin \text{co}(\nabla_M)$, as desired. \sharp .

8.2 Connecting μ with $\bar{\sigma}(M)$

The convex hull of ∇_M determines whether or not $D := I$ is the optimum scaling. Following (Doyle, 1982) we ask, “what is true about M if $0 \in \nabla_M$?” Since $\nabla_M \subset \text{co}(\nabla_M)$, certainly $D := I$ is optimal, but is anything else true? The answer links the upper bound and μ .

Theorem 8.3 *Let $M \in \mathbf{C}^{n \times n}$ be given, along with a block structure Δ , and define ∇_M accordingly (equations (8.1), (8.3), (8.5), and (8.6)). Then, $\bar{\sigma}(M) = \mu_\Delta(M)$ if and only if $0 \in \nabla_M$.*

Proof: The following four statements are equivalent:

1. $0 \in \nabla_M$
2. There exists $\eta \in \mathbf{C}^r$, $\|\eta\| = 1$ and $Q \in \mathbf{Q}$ with $QU\eta = V\eta$
3. There exists $\xi \in \mathbf{C}^n$, $\|\xi\| = 1$ and $Q \in \mathbf{Q}$ with $QM\xi = \bar{\sigma}\xi$
4. $\bar{\sigma}(M) = \mu_\Delta(M)$. \sharp

1 \rightarrow 2: From the definition of ∇_M , (8.6), $0 \in \nabla_M$ implies that for some $\eta \in \mathbf{C}^r$, $\|\eta\| = 1$,

$$\begin{aligned} A_i\eta\eta^*A_i^* - B_i\eta\eta^*B_i^* &= 0 & i \leq S \\ \eta^*(E_j^*E_j - H_j^*H_j)\eta &= 0 & j \leq F-1 \end{aligned} \quad (8.8)$$

Obviously, for $i \leq S$, there is a phase $e^{j\theta_i}$ such that $e^{j\theta_i}A_i\eta = B_i\eta$. For $j \leq F-1$, $\|E_j\eta\| = \|H_j\eta\|$, so there exists a unitary matrix Q_j such that $Q_jE_j\eta = H_j\eta$. The only thing left is the last full block. Since $\|U\eta\| = \|V\eta\|$ we must have $\|E_F\eta\| = \|H_F\eta\|$. This gives a unitary matrix Q_F with $Q_FE_F\eta = H_F\eta$. Arranging the phases and Q 's in a block diagonal fashion gives statement 2.

2 \rightarrow 1: This follows along the lines of 1 \rightarrow 2.

2 \rightarrow 3: The matrix M has a SVD of $M = \bar{\sigma}UV^* + U_2\Sigma_2V_2^*$. Hence $QM(V\eta) = \bar{\sigma}QU\eta = \bar{\sigma}V\eta$. Defining $\xi = V\eta$ gives statement 3.

3 \rightarrow 2: A SVD of QM is $QM = \bar{\sigma}(QU)V^* + (QU_2)\Sigma_2V_2^*$. If $QM\xi = \bar{\sigma}\xi$, then ξ must lie in the subspace spanned by the right singular vectors associated with $\bar{\sigma}$. Hence there is a vector η , satisfying $\xi = V\eta$. Obviously $\|\eta\| = 1$ and

$$QU\eta = QUV^*\xi = \frac{1}{\bar{\sigma}}QM\xi = \xi = V\eta \quad (8.9)$$

3 \rightarrow 4: $QM\xi = \bar{\sigma}\xi$ implies that $\mu_{\Delta}(M) = \max_{Q \in \mathbf{Q}} \rho(QM) \geq \rho(QM) \geq \bar{\sigma}(M)$. However, $\bar{\sigma}$ is always an upper bound for μ , hence we must have equality.

4 \rightarrow 3: This is clear, since $\max_{Q \in \mathbf{Q}} \rho(QM) = \mu_{\Delta}(M)$. $\#$

Theorem 8.3 can be used to relate the upper bound and $\mu_{\Delta}(M)$. In particular, we consider block structures Δ that have the following property: for all $W \in \mathbf{C}^{n \times n}$, $0 \in \text{co}(\nabla_W)$ always implies $0 \in \nabla_W$. Note that while this property is stated in terms of ∇_W , it is actually a property of the underlying block structure. We will say that a block structure satisfying this property is μ -simple. In Section 9, we will completely characterize which block structures are μ -simple, and which block structures are not. For now, we prove that μ -simple block structures always have μ equal to the upper bound.

Theorem 8.4 *Suppose the block structure Δ is μ -simple. Then, for every $M \in \mathbf{C}^{n \times n}$,*

$$\mu_{\Delta}(M) = \inf_{D \in \mathbf{D}} \bar{\sigma} \left(D^{\frac{1}{2}} M D^{-\frac{1}{2}} \right).$$

Proof: Let $\beta = \inf_{D \in \mathbf{D}} \bar{\sigma} \left(D^{\frac{1}{2}} M D^{-\frac{1}{2}} \right)$. Let D_k be a sequence in \mathbf{D} such that $\bar{\sigma} \left(D_k^{\frac{1}{2}} M D_k^{-\frac{1}{2}} \right)$ converges to β as $k \rightarrow \infty$. Denote $W_k = D_k^{\frac{1}{2}} M D_k^{-\frac{1}{2}}$. Since the sequence W_k is bounded, it has a convergent subsequence with limit W . Obviously, by continuity of $\bar{\sigma}$ and μ , $\bar{\sigma}(W) = \beta$ and $\mu_{\Delta}(M) = \mu_{\Delta}(W)$. We claim that $0 \in \text{co}(\nabla_W)$. If not, then there exist $D \in \mathbf{D}$ and $\epsilon > 0$ such that $\bar{\sigma} \left(D^{\frac{1}{2}} W D^{-\frac{1}{2}} \right) = \beta - \epsilon$. Choose k so that $\|W_k - W\| < \frac{\epsilon}{2\sqrt{\kappa(D)}}$, where $\kappa(\cdot)$ denotes condition number. Then

$$\|D^{\frac{1}{2}} (W_k - W) D^{-\frac{1}{2}}\| < \frac{\epsilon}{2},$$

which yields

$$\|D^{\frac{1}{2}} W_k D^{-\frac{1}{2}}\| < \beta - \frac{\epsilon}{2}.$$

This contradicts that β was the infimum, thus indeed $0 \in \text{co}(\nabla_W)$. By hypothesis, this means $0 \in \nabla_W$ so by Theorem 8.3, $\mu_{\Delta}(W) = \bar{\sigma}(W)$. Recalling continuity, we get $\mu_{\Delta}(M) = \beta$ as desired. $\#$

Consider the minimization over the D 's. Since we are *minimizing* the *maximum* singular value, the top singular values tend to coalesce, so that at the minimum, the multiplicity of $\bar{\sigma}$ is greater than or equal to 2. This is typical of any "min max" problem. Suppose though, that at the minimum, $\bar{\sigma} \left(D_{\text{opt}}^{\frac{1}{2}} M D_{\text{opt}}^{-\frac{1}{2}} \right)$ was distinct. Obviously, since we are at a minimum, we must have $0 \in \text{co}(\nabla)$. But if the multiplicity of $\bar{\sigma}$ is only 1, then ∇ is a **single point**, hence $\nabla = \{0\}$. This reasoning gives:

Corollary 8.5 *If, at the minimum of $\bar{\sigma} \left(D^{\frac{1}{2}} M D^{-\frac{1}{2}} \right)$, the maximum singular value has multiplicity of 1, then $\mu(M) = \min_{D \in \mathbf{D}} \bar{\sigma} \left(D^{\frac{1}{2}} M D^{-\frac{1}{2}} \right)$.*

9 Properties of ∇

In this section, we study the convexity properties of the set ∇ , since the relationship between $\mu_{\Delta}(M)$ and $\inf_{D \in \mathbf{D}} \bar{\sigma}(D^{\frac{1}{2}}MD^{-\frac{1}{2}})$ depend on the relationship between ∇ and $\text{co}(\nabla)$. It will be shown, that for some block structures Δ , the implication

$$0 \in \text{co}(\nabla_W) \rightarrow 0 \in \nabla_W$$

holds for **every** complex matrix W of appropriate dimensions. Hence, for those block structures,

$$\inf_{D \in \mathbf{D}} \bar{\sigma}(D^{\frac{1}{2}}MD^{-\frac{1}{2}}) = \mu_{\Delta}(M)$$

for every matrix M . Likewise, for other block structures, specific matrices can be constructed for which the upper bound can be shown to be greater than μ . The upper bound *may* be equal to μ for certain matrices (see Theorem 8.3 for example) but in general, the upper bound is not equal to μ .

These upcoming results are summarized in the Table reftab.mubnd, which indicates section numbers for the accompanying derivation or example. Note that the $(S = 0, F = 1)$ entry is trivial, and the $(S = 1, F = 0)$ entry implies that for any $M \in \mathbf{C}^{n \times n}$

$$\rho(M) = \inf_{\substack{D \in \mathbf{C}^{n \times n} \\ D = D^* > 0}} \bar{\sigma}(D^{\frac{1}{2}}MD^{-\frac{1}{2}})$$

which is a well known fact.

Before beginning, we make a notational change, for ease of exposition. Although the set ∇ was defined as a subset of block diagonal, $n \times n$ Hermitian matrices, in this section we identify ∇ with the set $\mathbf{H}^{r_1} \times \mathbf{H}^{r_2} \times \dots \times \mathbf{H}^{r_S} \times \mathbf{R}^{F-1}$.

9.1 $S = 0, F = 2$

The situation with two full blocks is relatively simple. Referring back to (8.5), ∇ will always have the form

$$\nabla = \{\eta^*(E^*E - F^*F)\eta : \eta \in \mathbf{C}^r, \|\eta\| = 1\} \quad (9.1)$$

for some given $r > 0$ and $E, F \in \mathbf{C}^{m_1 \times r}$. Since $E^*E - F^*F$ is Hermitian, ∇ is just a closed interval in the real line. Obviously, this is always convex, so if $0 \in \text{co}(\nabla)$, in fact, $0 \in \nabla$. Hence by Theorem 8.4:

Theorem 9.1 *If Δ consists of two full blocks ($S = 0, F = 2$), then*

$$\mu_{\Delta}(M) = \inf_{D \in \mathbf{D}} \bar{\sigma}(D^{\frac{1}{2}}MD^{-\frac{1}{2}}).$$

Remark 9.2 The two block case was first solved by Redheffer (1959) with a quite different approach involving the use of Schauder's fixed point theorem (Dunford and Schwartz, 1958, 1963).

9.2 $S = 0, F = 4$ (Morton and Doyle, 1985)

Consider the case when Δ consists of four 1×1 blocks, so $S = 0, F = 4$, and $m_j = 1$ for each j . Let a, b , and c be positive real numbers, d and f be complex numbers, and ψ_1 and ψ_2 be real numbers. Define matrices $U, V \in \mathbf{C}^{4 \times 2}$ by

$$U = \begin{bmatrix} a & 0 \\ b & b \\ c & jc \\ d & f \end{bmatrix}, \quad V = \begin{bmatrix} 0 & a \\ b & -b \\ c & -jc \\ e^{j\psi_1} f & e^{j\psi_2} d \end{bmatrix}$$

For the time being, suppose that these are both unitary matrices, so that $U^*U = V^*V = I_2$. Later we will actually assign the correct values, but at the moment we just assume this is already done. Then define $M \in \mathbf{C}^{4 \times 4}$ by

$$M := UV^* \tag{9.2}$$

With the assumptions of unitariness on U and V , (9.2) is a singular value decomposition of M . M has two singular values at 1, and two singular values at 0. With respect to the block structure Δ that we have defined, what properties does the set ∇_M have? In particular:

- is $0 \in \text{co}(\nabla_M)$? If so, then $\inf_{D \in \mathbf{D}} \bar{\sigma} \left(D^{\frac{1}{2}} M D^{-\frac{1}{2}} \right) = 1$, otherwise, it is less than 1.
- is $0 \in \nabla_M$? If so, then $\mu(M) = \bar{\sigma}(M) = 1$, otherwise it is less than 1.

Since the multiplicity of the maximum singular value is 2, we can parametrize all unit vectors in \mathbf{C}^2 , and get a parametric representation of ∇_M . It is easy to see that any vector $\eta \in \mathbf{C}^2$, with $\|\eta\| = 1$ is of the form

$$\eta = \begin{bmatrix} e^{j\phi_1} \cos \theta \\ e^{j\phi_2} \sin \theta \end{bmatrix}$$

for some real ϕ_1, ϕ_2 , and θ . As it turns out, ∇_M depends only on the difference $\phi_1 - \phi_2$, which we will denote as ϕ . Simply plugging in for the definition of ∇_M from section 8, we get

$$\nabla_M = \left\{ \begin{bmatrix} a^2 (\cos^2 \theta - \sin^2 \theta) \\ 4b^2 \sin \theta \cos \theta \cos \phi \\ 4c^2 \sin \theta \cos \theta \sin \phi \end{bmatrix} \in \mathbf{R}^3 : \phi, \theta \in \mathbf{R} \right\} \subset \mathbf{R}^3 \tag{9.3}$$

It is apparent that $0 \notin \nabla_M$. That would require (from the first coordinate in (9.3)) that $\theta = \frac{2n+1}{4}\pi$, for some integer n . The second and third coordinates being zero would then require both $\cos \phi = 0$ and $\sin \phi = 0$, which is impossible. Hence $0 \notin \nabla_M$, and $\mu(M) < 1$.

On the other hand, setting $\theta = 0$, and then $\theta = \frac{\pi}{2}$, gives that both $[a^2 \ 0 \ 0]^T$ and $[-a^2 \ 0 \ 0]^T$ are elements of ∇_M . Consequently, $0 \in \text{co}(\nabla_M)$. Therefore

$$\inf_{D \in \mathbf{D}} \bar{\sigma} \left(D^{\frac{1}{2}} M D^{-\frac{1}{2}} \right) = \bar{\sigma}(M) = 1$$

In order to complete the counterexample, we must choose the free variables so that U and V in (9.2) are unitary, as we said we could.

Set $\gamma = 3 + \sqrt{3}$ and $\beta = \sqrt{3} - 1$ and define $a = \sqrt{\frac{2}{\gamma}}$, $b = \frac{1}{\sqrt{\gamma}}$, $c = \frac{1}{\sqrt{\gamma}}$, $d = -\sqrt{\frac{\beta}{\gamma}}$, $f = (1+j)\sqrt{\frac{1}{\gamma\beta}}$, $\psi_1 = -\frac{\pi}{2}$ and $\psi_2 = \pi$. Some algebra later, we conclude that ∇_M is the set of all $x \in \mathbf{R}^3$, such that $\|x\| = \frac{2}{3+\sqrt{3}}$. Obviously, $0 \notin \nabla_M$, but $0 \in \text{co}(\nabla_M)$. Extensive searching over the set \mathbf{Q} in the lower bound formula has revealed that for M defined above, $\mu_{\Delta}(M)$ is approximately 0.87326. This counterexample proves that for every block structure Δ satisfying $S + F \geq 4$, there exist matrices M with

$$\mu_{\Delta}(M) < \inf_{D \in \mathbf{D}} \bar{\sigma} \left(D^{\frac{1}{2}} M D^{-\frac{1}{2}} \right).$$

9.3 $S = 0, F = 3$ (Doyle, 1982)

In this problem, for every matrix M , $\nabla_M \subset \mathbf{R}^2$, of the form

$$\nabla = \left\{ \left[\begin{array}{c} \eta^* H_1 \eta \\ \eta^* H_2 \eta \end{array} \right] \in \mathbf{R}^2 : \eta \in \mathbf{C}^r, \|\eta\| = 1 \right\} \subset \mathbf{R}^2 \quad (9.4)$$

for some integer r , and Hermitian matrices H_1 and $H_2 \in \mathbf{C}^{r \times r}$. In (Doyle, 1982), it is shown that this set is **always** convex, so that the upper bound is exactly equal to $\mu_{\Delta}(M)$. For completeness, the results needed to prove this are stated below.

Begin with some notation from (Doyle, 1982). For any positive integer r , define the sets $P^r := \{x \in \mathbf{C}^r : \|x\| = 1\}$ and $\mathbf{S}^r := \{v \in \mathbf{R}^{r+1} : \|v\| = 1\}$. If H_1, H_2, \dots, H_q are Hermitian matrices in $\mathbf{C}^{r \times r}$, define a function $f_H : P^r \rightarrow \mathbf{R}^q$ by

$$f_H(\eta) := \begin{bmatrix} \eta^* H_1 \eta \\ \eta^* H_2 \eta \\ \vdots \\ \eta^* H_q \eta \end{bmatrix} \in \mathbf{R}^q \quad (9.5)$$

for each $\eta \in P^r$.

Lemma 9.3 *Let q be a positive integer. Let $a_i, c_i \in \mathbf{R}$, and $b_i \in \mathbf{C}$ for $i = 1, \dots, q$. For each i , define a Hermitian 2×2 matrix H_i by*

$$H_i := \begin{bmatrix} a_i & b_i \\ \bar{b}_i & c_i \end{bmatrix}$$

Then there exists a vector $d \in \mathbf{R}^q$ and a matrix $V \in \mathbf{R}^{q \times 3}$ such that

$$f_H(P^2) := \{f_H(\eta) : \eta \in P^2\} = \{d + Vu : u \in \mathbf{S}^2\}.$$

where f_H is defined in (9.5).

Lemma 9.4 *Let $d \in \mathbf{R}^2$ and $V \in \mathbf{R}^{2 \times 3}$. Then the set $\{d + Vu : u \in \mathbf{S}^2\} \subset \mathbf{R}^2$ is convex.*

Hence, for $q = 2$ and $r = 2$, the set $f(P^2) \in \mathbf{R}^2$ is convex. For a block structure with $S = 0, F = 3$, the set ∇ is always of the form $f(P^r) \in \mathbf{R}^2$ (ie. $q = 2$). Recall though, that r is the multiplicity of the maximum singular value. Conceivably, this can be any positive number, hence the above reasoning needs to be generalized for $r > 2$.

Theorem 9.5 *Let r be any positive integer. Let $H_1, H_2 \in \mathbf{C}^{r \times r}$ be Hermitian matrices. Then the set*

$$f_H(P^r) = \left\{ \begin{bmatrix} \eta^* H_1 \eta \\ \eta^* H_2 \eta \end{bmatrix} \in \mathbf{R}^2 : \eta \in \mathbf{C}^r, \|\eta\| = 1 \right\} \quad (9.6)$$

is convex.

9.4 $S = 1, F = 1$

Consider a block structure of *one* repeated scalar block, and *one* full block, $S = F = 1$. Recall the definition of ∇_M , equation (8.6). With this structure, the set ∇_M will always be of the form

$$\nabla = \{A\eta\eta^*A^* - B\eta\eta^*B^* : \eta \in \mathbf{C}^r, \|\eta\| = 1\} \quad (9.7)$$

for some given $r > 0$ and $A, B \in \mathbf{C}^{r_1 \times r}$. It is easy to see that in general, ∇ is not convex. For instance, take $A = I$ and $B = 0$. However the following is always true.

Theorem 9.6 *Let ∇ be defined as in (9.7), for arbitrary matrices A and B of appropriate dimensions. If $0 \in \text{co}(\nabla)$, then $0 \in \nabla$.*

Proof: Suppose that $0 \in \text{co}(\nabla)$. Then, for some integer p , there exist nonnegative α_i with $\sum_{i=1}^p \alpha_i = 1$ and vectors $\eta_i \in \mathbf{C}^r$ with $\|\eta_i\| = 1$ such that

$$\sum_{i=1}^p \alpha_i (A\eta_i\eta_i^*A^* - B\eta_i\eta_i^*B^*) = 0 \quad (9.8)$$

which is rewritten as

$$A \left(\sum_{i=1}^p \alpha_i \eta_i \eta_i^* \right) A^* = B \left(\sum_{i=1}^p \alpha_i \eta_i \eta_i^* \right) B^* \quad (9.9)$$

Since the α_i are nonnegative, and not all 0, the dyad summation in (9.9) is a positive semidefinite matrix that is not zero. Let $X^{\frac{1}{2}}$ be its Hermitian, positive semidefinite square root. Therefore $AX^{\frac{1}{2}}X^{\frac{1}{2}}A^* = BX^{\frac{1}{2}}X^{\frac{1}{2}}B^*$. Hence, there is a unitary matrix V such that $AX^{\frac{1}{2}} = BX^{\frac{1}{2}}V$. Let v be an eigenvector of V (with eigenvalue $e^{j\theta}$) such that $X^{\frac{1}{2}}v \neq 0$, and define $u := X^{\frac{1}{2}}v$. Note that u is nonzero. This gives $Au = e^{j\theta}Bu$, which implies that $0 \in \nabla$. $\#$

This theorem, along with the LFT machinery developed earlier, can be used to give μ -based derivations of several standard results in linear systems theory, such as the Bounded Real Lemma and the Kalman-Yacovitch-Popov Lemma. These are relatively straightforward exercises and will not be pursued further here.

9.5 $S = 2, F = 0$

The block structure considered has $S = 2$ and $F = 0$. A cumbersome example which established the same conclusion appeared in (Anderson, Agathoklis, et al, 1986). The example presented

here is minimal, in the sense that no smaller problem (“smaller” meaning dimension of blocks and M) could be a counterexample (by results in section 9.4). The dimension of each repeated scalar block is 2.

(a) Let $a \in (0, 1)$ and $\gamma \in (0, 1)$ be given. Define the matrix $M \in \mathbf{R}^{4 \times 4}$ by

$$M := \begin{bmatrix} 0 & 1 & 0 & 1 \\ \gamma & 0 & \gamma & 0 \\ 2a & 0 & a & 0 \\ 0 & -2a & 0 & -a \end{bmatrix}$$

Define a block structure $\mathbf{\Delta}_2 := \{\delta_2 I_{2 \times 2} : \delta_2 \in \mathbf{C}\}$.

(b) For all $\Delta_2 \in \mathbf{B}_2$ the LFT $\mathcal{S}(M, \Delta_2)$ is well defined, and appears as

$$\mathcal{S}(M, \Delta_2) = \begin{bmatrix} 0 & \frac{1 - a\delta_2}{1 + a\delta_2} \\ \gamma \frac{1 + a\delta_2}{1 - a\delta_2} & 0 \end{bmatrix}. \quad (9.10)$$

Note that for each such $\Delta_2 = \delta_2 I_2$, the spectral radius of $\mathcal{S}(M, \Delta_2)$ is simply $\sqrt{\gamma}$, which by assumption is less than 1. With respect to the structure

$$\mathbf{\Delta} := \{\text{diag}[\delta_1 I_2, \delta_2 I_2] : \delta_i \in \mathbf{C}\},$$

Theorem 4.3 implies that $\mu_{\mathbf{\Delta}}(M) < 1$.

(c) Consider the product of two linear fractional transformations with different Δ_2 's in \mathbf{B}_2 .

$$\mathcal{S}(M, -I_2) \mathcal{S}(M, I_2) = \begin{bmatrix} \gamma \frac{(1+a)^2}{(1-a)^2} & 0 \\ 0 & \gamma \frac{(1-a)^2}{(1+a)^2} \end{bmatrix}$$

For any $\gamma \in (0, 1)$, it is easy to choose $a \in (0, 1)$ so that the spectral radius of the above product is greater than 1. For such choices, then, we must have

$$\inf_{D \in \mathbf{D}} \bar{\sigma} \left(D^{\frac{1}{2}} M D^{-\frac{1}{2}} \right) \geq 1,$$

where \mathbf{D} be the scaling set associated with $\mathbf{\Delta}$. Otherwise, by Lemma 4.9, the spectral radius of any product of these LFT's would be less than 1.

Remark 9.7 A deeper analysis can show that by proper choice of γ and a , the value of

$$\inf_{D \in \mathbf{D}} \bar{\sigma} \left(D^{\frac{1}{2}} M D^{-\frac{1}{2}} \right)$$

can be made arbitrarily close to $1 + \sqrt{2}$ while $\mu_{\mathbf{\Delta}}(M) < 1$.

9.6 $S = 1, F = 2$

Next is an example for a block structure with $S = 1$ and $F = 2$. Again, the example here is minimal — no smaller example could be a counterexample for this block structure. It is broken down into 8 facts.

(a) Let $\Delta_2 = \{\text{diag} [\delta_1, \delta_2] : \delta_i \in \mathbf{C}\}$. Then for any complex $\tau \neq 0$,

$$\mu_{\Delta_2} \left(\begin{bmatrix} 0 & \frac{1}{\tau} \\ \tau & 0 \end{bmatrix} \right) = 1.$$

(b) Let $a \in \mathbf{C}$ with $|a| < 1$. Define G on $|\delta| \leq 1$ as

$$G(\delta) = \begin{bmatrix} 0 & \frac{1+a\delta}{1-a\delta} \\ \frac{1-a\delta}{1+a\delta} & 0 \end{bmatrix} \quad (9.11)$$

Note that everywhere in the unit disk, G is defined and looks like $\begin{bmatrix} 0 & \frac{1}{\tau} \\ \tau & 0 \end{bmatrix}$. Hence from

(a)

$$\sup_{|\delta| \leq 1} \mu_{\Delta_2}(G(\delta)) = 1$$

(c) $G(\delta)$ in (9.11) can be written as a linear fractional transformation. In particular, define the matrix M by

$$M := \begin{bmatrix} -a & 0 & -2a & 0 \\ 0 & a & 0 & 2a \\ 0 & 1 & 0 & 1 \\ 1 & 0 & 1 & 0 \end{bmatrix} \quad (9.12)$$

It is simple to verify that for each $|\delta| \leq 1$, $G(\delta) = \mathcal{S}(\delta I_2, M)$.

(d) Define $\Delta_1 := \{\delta I_2 : \delta \in \mathbf{C}\}$, and $\Delta_2 := \{\text{diag} [\delta_1, \delta_2] : \delta_i \in \mathbf{C}\}$ and Δ the augmentation of the two sets. Certainly $\mu_{\Delta}(M)$ makes sense (dimensions are compatible), and $\mu_{\Delta}(M) \geq 1$, since $\mu_2(M_{22}) = 1$. Using (b) and (c), and Theorem 4.3, gives $\mu_{\Delta}(M) \leq 1$. Therefore $\mu_{\Delta}(M) = 1$.

(e) Define the usual scaling sets \mathbf{D}_1 and \mathbf{D}_2 compatible with Δ_1 and Δ_2 . For any $D_2 \in \mathbf{D}_2$

$$D_2^{\frac{1}{2}} \mathcal{S}(\delta I_2, M) D_2^{-\frac{1}{2}} = \begin{bmatrix} 0 & \sqrt{\frac{d_1}{d_2}} \frac{1+a\delta}{1-a\delta} \\ \sqrt{\frac{d_2}{d_1}} \frac{1-a\delta}{1+a\delta} & 0 \end{bmatrix} \quad (9.13)$$

Hence, with some simple calculus, it is easy to verify that for any $\beta \geq 1$,

$$\sup_{|\delta| \leq \frac{1}{\beta}} \bar{\sigma} \left(D_2^{\frac{1}{2}} \mathcal{S}(\delta I_2, M) D_2^{-\frac{1}{2}} \right) \geq \frac{\beta + |a|}{\beta - |a|}.$$

(f) **Fact:** Let $\gamma > 0$. If there is a $\Delta_1 \in \Delta_1$, $\bar{\sigma}(\Delta_1) \leq \frac{1}{\gamma}$ such that

- $I - M_{11}\Delta_1$ is invertible

- $\bar{\sigma}[\mathcal{S}(\Delta_1, M)] \geq \gamma$

then

$$\inf_{D_1 \in \mathbf{D}_1} \bar{\sigma} \left[\left(\begin{array}{cc} D_1^{\frac{1}{2}} & 0 \\ 0 & I \end{array} \right) \left(\begin{array}{cc} M_{11} & M_{12} \\ M_{21} & M_{22} \end{array} \right) \left(\begin{array}{cc} D_1^{-\frac{1}{2}} & 0 \\ 0 & I \end{array} \right) \right] \geq \gamma.$$

This fact is simply the contrapositive of Lemma 4.9.

- (g) If we choose a $\beta \geq 1$ such that $\frac{\beta+|a|}{\beta-|a|} \geq \beta$, then we can apply the results from (e) and (f) above to conclude that

$$\inf_{D_i \in \mathbf{D}_i} \bar{\sigma} \left[\left(\begin{array}{cc} D_1^{\frac{1}{2}} & 0 \\ 0 & D_2^{\frac{1}{2}} \end{array} \right) \left(\begin{array}{cc} M_{11} & M_{12} \\ M_{21} & M_{22} \end{array} \right) \left(\begin{array}{cc} D_1^{-\frac{1}{2}} & 0 \\ 0 & D_2^{-\frac{1}{2}} \end{array} \right) \right] \geq \beta.$$

The logic is as follows: first suppose β is chosen so that $\frac{\beta+|a|}{\beta-|a|} \geq \beta$. Then from equation (9.13) we know that for every $D_2 \in \mathbf{D}_2$, there is a $\delta \in \mathbf{C}$ with $|\delta| \leq \frac{1}{\beta}$ such that

$$\bar{\sigma} \left(D_2^{\frac{1}{2}} \mathcal{S}(\delta I_2, M) D_2^{-\frac{1}{2}} \right) \geq \beta$$

This satisfies the conditions of (f), therefore, for each $D_2 \in \mathbf{D}_2$

$$\inf_{D_1 \in \mathbf{D}_1} \bar{\sigma} \left[\left(\begin{array}{cc} D_1^{\frac{1}{2}} & 0 \\ 0 & D_2^{\frac{1}{2}} \end{array} \right) \left(\begin{array}{cc} M_{11} & M_{12} \\ M_{21} & M_{22} \end{array} \right) \left(\begin{array}{cc} D_1^{-\frac{1}{2}} & 0 \\ 0 & D_2^{-\frac{1}{2}} \end{array} \right) \right] \geq \beta. \quad (9.14)$$

Carrying out the infimum over \mathbf{D}_2 in (9.14) yields

$$\inf_{D \in \mathbf{D}} \bar{\sigma} \left(D^{\frac{1}{2}} M D^{-\frac{1}{2}} \right) \geq \beta$$

where \mathbf{D} is the diagonal augmentation of \mathbf{D}_1 and \mathbf{D}_2 . Therefore the question becomes: “What is the largest β such that $\frac{\beta+|a|}{\beta-|a|} \geq \beta$?” Simple algebra gives the largest β as $\beta = \frac{|a|+1+\sqrt{|a|^2+6|a|+1}}{2}$. Note that as $|a| \nearrow 1$, the quantity $\beta \nearrow 1 + \sqrt{2}$.

- (h) In summary: Let $\epsilon > 0$. Choose $a \in \mathbf{C}$, $|a| < 1$ such that

$$\frac{|a| + 1 + \sqrt{|a|^2 + 6|a| + 1}}{2} > 1 + \sqrt{2} - \epsilon.$$

Define M as in (9.12). Then, with respect to the augmented structure described in (d), $\mu_{\Delta}(M) = 1$ but $\inf_{D \in \mathbf{D}} \bar{\sigma} \left(D^{\frac{1}{2}} M D^{-\frac{1}{2}} \right) > 1 + \sqrt{2} - \epsilon$.

9.7 $M \in \mathbf{R}^{n \times n}$, $S = 0$, $F = 2$

If M is real, and the block structure Δ consists of two full blocks, then the smallest perturbation $\Delta \in \mathbf{\Delta}$ making $I - M\Delta$ singular will actually be a real matrix, rather than complex. The proof is rather simple using the ∇ set. We also note that this result can be found in (Redheffer, 1959). An elementary result from linear algebra is the key idea.

Lemma 9.8 *Suppose r is a positive integer, and $H \in \mathbf{R}^{r \times r}$ is symmetric. Then*

$$\{\eta^* H \eta : \eta \in \mathbf{C}^r, \|\eta\| = 1\} = \{\eta^T H \eta : \eta \in \mathbf{R}^r, \|\eta\| = 1\}$$

In view of this, suppose $M \in \mathbf{R}^{(n+m) \times (n+m)}$, $\Delta = \{\text{diag}[\Delta_1, \Delta_2] : \Delta_1 \in \mathbf{C}^{n \times n}, \Delta_2 \in \mathbf{C}^{m \times m}\}$ and the optimal D scaling has been computed. Note that in a 2-block problem, if the infimum is **not** achieved, then it must be that either $M_{12} = 0$ or $M_{21} = 0$, and $\mu_\Delta(M) = \max\{\bar{\sigma}(M_{11}), \bar{\sigma}(M_{22})\}$. Then, with singular vectors, it is possible to construct a **real** perturbation of the form $\Delta := \text{diag}[\Delta_1, 0]$ or $\Delta := \text{diag}[0, \Delta_2]$ such that $I - M\Delta$ is singular, and $\bar{\sigma}(\Delta) = \frac{1}{\mu_\Delta(M)}$. Next, consider the case when the infimum is achieved. Let D be the optimal scaling, and define $W := D^{\frac{1}{2}} M D^{-\frac{1}{2}}$. Since the optimal D scaling is of the form $\text{diag}[d_1 I_n, I_m]$, where $d_1 > 0$, it is clear that W is still real. Hence, $0 \in \text{co}(\nabla_W)$. Then, for some $U \in \mathbf{R}^{(n+m) \times r}$, $V \in \mathbf{R}^{(n+m) \times r}$,

$$W = \sigma_1 U V^* + U_2 \Sigma_2 V_2^*$$

and

$$\mu_\Delta(M) = \sigma_1 = \bar{\sigma}(W).$$

If U and V are partitioned with respect to the block structure as

$$U = \begin{bmatrix} E_1 \\ E_2 \end{bmatrix}, \quad V = \begin{bmatrix} F_1 \\ F_2 \end{bmatrix}$$

then ∇_W is

$$\nabla_W := \{\eta^* (E_1^* E_1 - F_1^* F_1) \eta : \eta \in \mathbf{C}^r, \|\eta\| = 1\}$$

By assumption, the D scaling is optimal, so $0 \in \text{co}(\nabla_W) = \nabla_W$. Using the lemma, this implies there is a $\eta \in \mathbf{R}^r$, with $\|\eta\| = 1$ such that $\|E_i \eta\| = \|F_i \eta\|$ for $i = 1, 2$. It is easy then to construct **real**, orthogonal matrices Q_1 and Q_2 such that $Q_i E_i \eta = F_i \eta$. Defining $Q := \text{diag}[Q_1, Q_2]$ yields

$$\det\left(I - \left(\frac{1}{\sigma_1} Q\right) M\right) = 0$$

which shows what we had claimed — in the two-block (full blocks) μ problem, with M real, the minimizing perturbation may be taken to be a real matrix.

The next theorem is a mild generalization of these ideas.

Theorem 9.9 *Let $\Delta_R \in \mathbf{R}^{n \times n}$ be a given structure, and define the following 4 augmented structures:*

$$\begin{aligned} \Delta_{rrr} &= \{\text{diag}[\Delta_R, \Delta_1, \Delta_2] : \Delta_R \in \Delta_R, \Delta_1 \in \mathbf{R}^{n_1 \times n_1}, \Delta_2 \in \mathbf{R}^{n_2 \times n_2}\} \\ \Delta_{rrc} &= \{\text{diag}[\Delta_R, \Delta_1, \Delta_2] : \Delta_R \in \Delta_R, \Delta_1 \in \mathbf{R}^{n_1 \times n_1}, \Delta_2 \in \mathbf{C}^{n_2 \times n_2}\} \\ \Delta_{rcr} &= \{\text{diag}[\Delta_R, \Delta_1, \Delta_2] : \Delta_R \in \Delta_R, \Delta_1 \in \mathbf{C}^{n_1 \times n_1}, \Delta_2 \in \mathbf{R}^{n_2 \times n_2}\} \\ \Delta_{rcc} &= \{\text{diag}[\Delta_R, \Delta_1, \Delta_2] : \Delta_R \in \Delta_R, \Delta_1 \in \mathbf{C}^{n_1 \times n_1}, \Delta_2 \in \mathbf{C}^{n_2 \times n_2}\} \end{aligned}$$

Then for $M \in \mathbf{R}^{(n+n_1+n_2) \times (n+n_1+n_2)}$,

$$\mu_{\Delta_{rrr}}(M) = \mu_{\Delta_{rrc}}(M) = \mu_{\Delta_{rcr}}(M) = \mu_{\Delta_{rcc}}(M)$$

Proof: The proof follows from the previous discussion and Theorem 4.3. \sharp

9.8 $M \in \mathbf{R}^{n \times n}, S = 0, F = 3$

Unfortunately, the argument used above breaks down in this case, and no longer may the smallest perturbation be assumed real. The following is from (Skogestad, 1987) and (Packard and Doyle, 1990). The perturbation set is 3 1×1 blocks. Let $U, V \in \mathbf{R}^{3 \times 2}$ be

$$U = \begin{bmatrix} 0 & \beta \\ \gamma & \alpha \\ \gamma & -\alpha \end{bmatrix}, \quad V = \begin{bmatrix} -\beta & 0 \\ \alpha & -\gamma \\ \alpha & \gamma \end{bmatrix}$$

where $\alpha, \gamma, \beta \in \mathbf{R}$, and have been chosen so that $U^T U = V^T V = I_2$ (that is easy to do). Define $M := UV^T \in \mathbf{R}^{3 \times 3}$. Then $\bar{\sigma}(M) = 1$, and $\eta \in \mathbf{C}^2, \|\eta\| = 1$, parametrized by

$$\eta = \begin{bmatrix} e^{j\psi} \cos \theta \\ e^{j\phi} \sin \theta \end{bmatrix}$$

gives

$$\nabla_M = \left\{ \begin{bmatrix} -\beta^2 \cos 2\theta \\ (\gamma^2 - \alpha^2) \cos 2\theta + 4 \cos(\psi - \phi) \gamma \alpha \cos \theta \sin \theta \end{bmatrix} : \theta, \psi, \phi \in \mathbf{R} \right\}$$

It is easy to see that $0 \in \nabla_M$, by choosing $\theta = \frac{2n+1}{4}\pi$ and $\psi - \phi = \frac{2m+1}{2}\pi$ for any integers n, m . The only vectors η which lead to $0 \in \nabla_M$ are

$$\eta = \begin{bmatrix} \pm j e^{j\phi} \frac{1}{\sqrt{2}} \\ \pm e^{j\phi} \frac{1}{\sqrt{2}} \end{bmatrix}$$

which is always complex. Consequently, the only matrices satisfying $\Delta \in \mathbf{\Delta}, \bar{\sigma}(\Delta) = 1$, and $I - M\Delta$ singular are complex perturbations.

9.9 $M \in \mathbf{R}^{n \times n}, S = 1, F = 1$

Again, the smallest perturbations are in general complex. Suppose $G(z)$ is a stable, n 'th order, SISO transfer function with $\|G\|_\infty = 1, |G(1)| < 1$, and $|G(-1)| < 1$. The state-space matrix M of this transfer function will have $\mu_{\mathbf{\Delta}}(M) = 1$, but all of the perturbations $\Delta = \text{diag}[\delta_1 I_n, \delta_2]$ satisfying $\bar{\sigma}(\Delta) = 1$, and $\det(I - M\Delta) = 0$ will be complex.

9.10 Optimal scalings for $\inf_{D \in \mathbf{D}} \bar{\sigma}(D^{\frac{1}{2}} M D^{-\frac{1}{2}})$ with $M \in \mathbf{R}^{n \times n}$

If the matrix M is real, then the minimum point in the convex hull of ∇_M is always real, so each block of the optimal $D \in \mathbf{D}$ can be chosen to be real. The proof is very simple.

Theorem 9.10 *Let \mathbf{D}_R be the set of real, symmetric members of \mathbf{D} . If M is real, then*

$$\inf_{D \in \mathbf{D}} \bar{\sigma}(D^{\frac{1}{2}} M D^{-\frac{1}{2}}) = \inf_{D_R \in \mathbf{D}_R} \bar{\sigma}(D_R^{\frac{1}{2}} M D_R^{-\frac{1}{2}}). \quad (9.15)$$

Proof: Let $D \in \mathbf{D}$ be given, with $D = D_r + jD_i$, and $\bar{\sigma} \left(D^{\frac{1}{2}} M D^{-\frac{1}{2}} \right) < \beta$. Note that $D_r = D_r^T > 0$, $D_r \in \mathbf{D}_R$, and $D_i = -D_i^T$. Then

$$M^T (D_r + jD_i) M - \beta^2 (D_r + jD_i) < 0. \quad (9.16)$$

Hence, the real part of (9.16) is also symmetric, negative definite and

$$\lambda_{\max} \left(M^T D_r M - \beta^2 D_r \right) < 0$$

which implies that

$$\bar{\sigma} \left(D_r^{\frac{1}{2}} M D_r^{-\frac{1}{2}} \right) < \beta,$$

so the infimums are the same. \ddagger

10 Transfer functions, state space matrices, μ and Robust Performance

In this section we begin by establishing some relationships between transfer function matrices and matrices made up of state-space realizations. We have already seen one instance of such a connection. In Section 4, it was proven that a finite dimensional linear system is stable, and has $\|\cdot\|_{\infty} < 1$ if and only if the structured singular value of the state space system matrix is less than 1 (recall, the block structure consisted of a repeated scalar block, and a full block). We explore this type of manipulation in more detail. With these relationships established, the robust performance properties of an uncertain linear system are investigated, and stated in terms of structured singular value tests. Finally, the connections between the μ theory and Riccati equations for testing \mathcal{H}_{∞} norm bounds are briefly reviewed.

10.1 Transfer Function matrices and State Space matrices

Let $M \in \mathbf{C}^{(n+m) \times (n+m)}$ be given, partitioned as usual, and define the transfer function matrix

$$G(z) := \mathcal{S} \left(\frac{1}{z} I_n, M \right) = M_{22} + M_{21} (zI_n - M_{11})^{-1} M_{12}.$$

Suppose that $\Delta \subset \mathbf{C}^{m \times m}$ is a block structure. Define Δ_P as

$$\Delta_P := \{ \text{diag} [\delta_1 I_n, \Delta] : \delta_1 \in \mathbf{C}, \Delta \in \Delta \}.$$

Applying Theorems 4.3 and 6.5, the following statements are equivalent:

1. $\rho(M_{11}) < 1$ and $\max_{\theta \in [0, 2\pi]} \mu_{\Delta} \left(G(e^{j\theta}) \right) < 1$
2. $\rho(M_{11}) < 1$ and $\max_{\theta \in [0, 2\pi]} \mu_{\Delta} \left(\mathcal{S} \left(e^{j\theta} I_n, M \right) \right) < 1$
3. $\rho(M_{11}) < 1$ and $\max_{\substack{\delta_1 \in \mathbf{C} \\ |\delta_1| \leq 1}} \mu_{\Delta} \left(\mathcal{S} (\delta_1 I_n, M) \right) < 1$

$$4. \mu_{\Delta_P}(M) < 1$$

Hence, the peak value of μ of a frequency response is related to a larger μ problem on the state space matrix of the transfer function in question. This generalizes the example in Section 4, where the $\|\cdot\|_\infty$ norm (maximum singular value across frequency) was considered.

Similar results are possible when the upper bound is used instead of μ . Suppose that $\mathbf{D} \subset \mathbf{C}^{m \times m}$ is the scaling set associated with Δ , as in (3.6). For any $D \in \mathbf{D}$, define

$$M_D := \begin{bmatrix} M_{11} & M_{12}D^{-\frac{1}{2}} \\ D^{\frac{1}{2}}M_{21} & D^{\frac{1}{2}}M_{22}D^{-\frac{1}{2}} \end{bmatrix}$$

Also, let

$$\begin{aligned} \Delta_\sigma &:= \mathbf{C}^{m \times m} \\ \Delta_N &:= \{\text{diag}[\delta_1 I_n, \Delta_2] : \delta_1 \in \mathbf{C}, \Delta_2 \in \mathbf{C}^{m \times m}\} \end{aligned}$$

Note that $\mu_{\Delta_\sigma}(\cdot)$ is simply the maximum singular value, and that Δ_N is μ -simple. Then, the following are equivalent.

1. $\rho(M_{11}) < 1$ and $\inf_{D \in \mathbf{D}} \|D^{\frac{1}{2}}GD^{-\frac{1}{2}}\|_\infty < 1$
2. $\rho(M_{11}) < 1$ and $\inf_{D \in \mathbf{D}} \max_{\substack{\delta \in \mathbf{C} \\ |\delta| \leq 1}} \bar{\sigma} \left[D^{\frac{1}{2}}\mathcal{S}(\delta I_n, M)D^{-\frac{1}{2}} \right] < 1$
3. $\rho(M_{11}) < 1$, and $\inf_{D \in \mathbf{D}} \max_{\substack{\delta \in \mathbf{C} \\ |\delta| \leq 1}} \mu_{\Delta_\sigma}(\mathcal{S}(\delta I_n, M_D)) < 1$
4. $\inf_{D \in \mathbf{D}} \mu_{\Delta_N}(M_D) < 1$
5. $\inf_{\substack{D \in \mathbf{D} \\ X \in \mathbf{C}^{n \times n}, X=X^* > 0}} \bar{\sigma} \left(\begin{bmatrix} X^{\frac{1}{2}} & 0 \\ 0 & D^{\frac{1}{2}} \end{bmatrix} M \begin{bmatrix} X^{-\frac{1}{2}} & 0 \\ 0 & D^{-\frac{1}{2}} \end{bmatrix} \right) < 1$

Also, if $M \in \mathbf{R}^{(n+m) \times (n+m)}$, then the scalings can be chosen to be real, so that the following are equivalent.

1. $\rho(M_{11}) < 1$ and $\inf_{D \in \mathbf{D}} \|D^{\frac{1}{2}}GD^{-\frac{1}{2}}\|_\infty < 1$
2. $\rho(M_{11}) < 1$ and $\inf_{D \in \mathbf{D}_R} \|D^{\frac{1}{2}}GD^{-\frac{1}{2}}\|_\infty < 1$
3. $\inf_{\substack{D \in \mathbf{D}_R \\ X \in \mathbf{R}^{n \times n}, X=X^T > 0}} \bar{\sigma} \left(\begin{bmatrix} X^{\frac{1}{2}} & 0 \\ 0 & D^{\frac{1}{2}} \end{bmatrix} M \begin{bmatrix} X^{-\frac{1}{2}} & 0 \\ 0 & D^{-\frac{1}{2}} \end{bmatrix} \right) < 1$

These relationships are very significant. Consider the simple situation where $\mathbf{D} := \{I_m\}$, in other words, an unscaled transfer function. The equivalences imply that the linear system is stable,

and has $\|\cdot\|_\infty$ norm less than 1 if and only if there is a state-coordinate transformation ($X^{\frac{1}{2}}$) such that the transformed state space matrix

$$\begin{bmatrix} X^{\frac{1}{2}} & 0 \\ 0 & I_m \end{bmatrix} M \begin{bmatrix} X^{-\frac{1}{2}} & 0 \\ 0 & I_m \end{bmatrix}.$$

is a contraction. This is intimately related to the characterization of \mathcal{H}_∞ norms using Riccati equations, (Willems, 1971a). This will be discussed further at the end of this section.

10.2 State-Space/Frequency Domain tests for Robust Performance

We begin with a matrix $M \in \mathbf{C}^{(n+n_p+m) \times (n+n_p+m)}$, partitioned as below, relating several variables of a linear system by

$$\begin{bmatrix} x_{k+1} \\ e_k \\ z_k \end{bmatrix} = \begin{bmatrix} M_{11} & M_{12} & M_{13} \\ M_{21} & M_{22} & M_{23} \\ M_{31} & M_{32} & M_{33} \end{bmatrix} \begin{bmatrix} x_k \\ d_k \\ w_k \end{bmatrix} \quad (10.1)$$

The uncertainty is modeled by a feedback loop from z to w through a structured $\Delta \in \mathbf{\Delta}$, where $\mathbf{\Delta}$ is a prescribed $m \times m$ block structure (note that we have assumed that the number of disturbance inputs equals the number of errors, and that the perturbation matrices are square — this can all be trivially generalized to include nonsquare situations). Hence, the uncertain system's output error e_k is driven by the input disturbance d_k , and the state equations are given as

$$\begin{bmatrix} x_{k+1} \\ e_k \end{bmatrix} = \mathcal{S}(M, \Delta) \begin{bmatrix} x_k \\ d_k \end{bmatrix} \quad (10.2)$$

With respect to the partition, $\mathcal{S}(M, \Delta)$ is

$$\begin{bmatrix} M_{11} & M_{12} \\ M_{21} & M_{22} \end{bmatrix} + \begin{bmatrix} M_{13} \\ M_{23} \end{bmatrix} \Delta (I - M_{33} \Delta)^{-1} \begin{bmatrix} M_{31} & M_{32} \end{bmatrix}$$

This is shown in Figure 10. Define three augmented block structures, $\mathbf{\Delta}_N$, $\mathbf{\Delta}_S$ and $\mathbf{\Delta}_P$ as

$$\mathbf{\Delta}_N := \{\text{diag}[\delta_1 I_n, \Delta_2] : \delta_1 \in \mathbf{C}, \Delta_2 \in \mathbf{C}^{n_p \times n_p}\}$$

$$\mathbf{\Delta}_S := \{\text{diag}[\Delta_N, \Delta] : \Delta_N \in \mathbf{\Delta}_N, \Delta \in \mathbf{\Delta}\}$$

$$\mathbf{\Delta}_P := \{\text{diag}[\Delta_2, \Delta] : \Delta_2 \in \mathbf{C}^{n_p \times n_p}, \Delta \in \mathbf{\Delta}\}$$

along with the corresponding scaling sets \mathbf{D}_N , \mathbf{D}_S and \mathbf{D}_P . Motivation for this notation is that the subscript N could mean norm or nominal, S could mean state-space, and P could mean performance. We begin with the main result for linear, time-invariant perturbations, (Doyle, Wall, et al, 1982), (Doyle and Packard, 1987).

Theorem 10.1 (Time-invariant, robust performance) *Given the matrices and sets as defined above, the following conditions are equivalent:*

1. *there exists a constant $\beta \in [0, 1)$ such that for each fixed $\Delta \in \mathbf{B}_\Delta$, the uncertain system (10.2) is well-posed ($I - M_{33}\Delta$ is invertible), stable, and for zero-initial-state-response, the error e satisfies $\|e\|_2 \leq \beta \|d\|_2$*

2. $\mu_{\Delta_S}(M) < 1$ (*SS μ test*)
3. $\rho(M_{11}) < 1$ and $\max_{\theta \in [0, 2\pi]} \mu_{\Delta_P}(\mathcal{S}(e^{j\theta} I_n, M)) < 1$ (*FD μ test*).

Proof: Introduce two intermediate statements:

- 1.5 $\mu_{\Delta}(M_{33}) < 1$ and $\max_{\Delta \in \mathbf{B}_{\Delta}} \mu_{\Delta_N}(\mathcal{S}(M, \Delta)) < 1$
- 2.5 $\rho(M_{11}) < 1$ and $\max_{\delta \in \mathbf{C}, |\delta| \leq 1} \mu_{\Delta_P}(\mathcal{S}(\delta I_n, M)) < 1$

The proof that $1 \Leftrightarrow 1.5$ follows from the definition of stability for a finite dimensional, linear, time-invariant, discrete time system, the relationship between H_{∞} norms and l_2 gain, and the equivalence between μ and the $\|\cdot\|_{\infty}$ norms for transfer functions, as developed in section 10. Items 1.5, 2 & 2.5 are equivalent by Theorem 4.3, while 2.5 and 3 are equivalent by Theorem 6.5.

Remark 10.2 Item 1 in this theorem is the desired robust performance conclusion. Item 1.5 rephrases Item 1, using the μ characterization of $\|\cdot\|_{\infty} < 1$. Items 2 and 3 are known respectively as the “state-space μ test” (SS μ) and the “frequency domain μ test” (FD μ). Both of these tests involve computing μ for various matrices. Recall that upper and lower bounds for μ are all that can be computed. Hence, we will investigate the additional conclusions that are possible when the $\bar{\sigma}(D^{\frac{1}{2}}MD^{-\frac{1}{2}})$ upper bound is used to implement the computational tests of items 2 and 3.

Remark 10.3 The FD μ test is what is most commonly associated with the structured singular value and is often referred to as a μ -plot. It is essentially a Bode magnitude plot with $\mu(\cdot)$ replacing $\bar{\sigma}(\cdot)$ or $|\cdot|$. The SS μ test was introduced in (Doyle and Packard, 1987).

10.3 Upper bounds

Using the $\bar{\sigma}(D^{\frac{1}{2}}MD^{-\frac{1}{2}})$ upper bound in place of μ , we can derive sufficient conditions for robust performance. The resulting state-space upper bound test (SSUB) and the frequency domain upper bound test (FDUB) are

- 2' $\inf_{D_S \in \mathbf{D}_S} \bar{\sigma}\left(D_S^{\frac{1}{2}}MD_S^{-\frac{1}{2}}\right) < 1$ (*SSUB*)
- 3' $\max_{\theta \in [0, 2\pi]} \inf_{D_P \in \mathbf{D}_P} \bar{\sigma}\left[D_P^{\frac{1}{2}}\mathcal{S}(e^{j\theta} I_n, M)D_P^{-\frac{1}{2}}\right] < 1$ (*FDUB*)

While the various μ tests given in Theorem 10.1 are all equivalent, these two upper bound tests are **very different**. In particular, recalling the results from the previous section on scaling a transfer function with a constant similarity transformation, the SSUB condition is actually equivalent to

$$\inf_{D_P \in \mathbf{D}_P} \max_{\theta \in [0, 2\pi]} \bar{\sigma}\left[D_P^{\frac{1}{2}}\mathcal{S}(e^{j\theta} I_n, M)D_P^{-\frac{1}{2}}\right] < 1 \quad (10.3)$$

This condition is much stronger than the frequency domain upper bound test, since in (10.3), the same $D_P \in \mathbf{D}_P$ must work for all $\theta \in [0, 2\pi]$. For that reason, we call equation (10.3) the *frequency domain constant D test*, *FDCD*. Listed, from strongest to weakest, the various conditions are:

$$\begin{aligned}
& \inf_{D_S \in \mathbf{D}_S} \bar{\sigma} \left(D_S^{\frac{1}{2}} M D_S^{-\frac{1}{2}} \right) < 1 && \text{(SSUB)} \\
& \quad \Downarrow \\
& \inf_{D_P \in \mathbf{D}_P} \max_{\theta \in [0, 2\pi]} \bar{\sigma} \left[D_P^{\frac{1}{2}} \mathcal{S} \left(e^{j\theta} I_n, M \right) D_P^{-\frac{1}{2}} \right] < 1 && \text{(FDCD)} \\
& \quad \Downarrow \nleftrightarrow \\
& \max_{\theta \in [0, 2\pi]} \inf_{D_P \in \mathbf{D}_P} \bar{\sigma} \left[D_P^{\frac{1}{2}} \mathcal{S} \left(e^{j\theta} I_n, M \right) D_P^{-\frac{1}{2}} \right] < 1 && \text{(FDUB)} \\
& \quad \Downarrow \nleftrightarrow \\
& \max_{\theta \in [0, 2\pi]} \mu_{\Delta_P} \left(\mathcal{S} \left(e^{j\theta} I_n, M \right) \right) < 1 && \text{(FD}\mu\text{)} \\
& \quad \Downarrow \\
& \mu_{\Delta_S}(M) < 1 && \text{(SS}\mu\text{)} \\
& \quad \Downarrow \\
& \text{Condition 1 in Theorem 10.1}
\end{aligned}$$

Note that in both instances where the implication is given as \Downarrow rather than \Downarrow , there truly is a gap. Also, there are two such gaps between the state space tests, SSUB and SS μ , while there is only one gap between the frequency domain tests, FDUB and FD μ . The top conditions are the strongest, and are equivalent to a very strong form of robust Lyapunov stability, (Boyd and Yang, 1989).

Given that the upper bound is computable, one might ask which test should be used, the state space upper bound test, SSUB (equivalently FDCD), or the frequency domain upper bound test, FDUB? The answer depends on the assumptions that are made about the perturbations. If the SSUB is used and the bound satisfied, then the robust performance conclusion holds for time-varying perturbations (and with proper interpretation, cone bounded nonlinear perturbations).

Theorem 10.4 *Let M be given as in (10.1), along with an uncertainty structure Δ . If there is a $D_S \in \mathbf{D}_S$ such that*

$$\bar{\sigma} \left(D_S^{\frac{1}{2}} M D_S^{-\frac{1}{2}} \right) = \beta < 1 \quad (10.4)$$

then there exist constants $c_1 \geq c_2 > 0$, such that for all perturbation sequences $\{\Delta_k\}_{k=0}^\infty$ with $\Delta_k \in \Delta$, $\bar{\sigma}(\Delta_k) < \frac{1}{\beta}$, the time-varying, uncertain system

$$\begin{bmatrix} x_{k+1} \\ e_k \end{bmatrix} = \mathcal{S}(M, \Delta_k) \begin{bmatrix} x_k \\ d_k \end{bmatrix} \quad (10.5)$$

is zero-input, exponentially stable, and furthermore, if $\{d_k\}_{k=0}^\infty \in l_2$, then

$$c_2 \left(1 - \beta^2 \right) \|x\|_2^2 + \|e\|_2^2 \leq \beta^2 \|d\|_2^2 + c_1 \|x_0\|^2$$

In particular, $\|e\|_2^2 \leq \beta^2 \|d\|_2^2 + c_1 \|x_0\|^2$.

Proof: Note that D_S will appear as $D_S = \text{diag}[D_1, d_2 I, D]$, where $D_1 = D_1^* > 0, D_1 \in \mathbf{C}^{n \times n}$. Using equation (10.4), it is easy to show that regardless of $\Delta_k \in \mathbf{\Delta}, \bar{\sigma}(\Delta_k) < \frac{1}{\beta}$, the norms of pertinent vectors satisfy

$$\|D_1^{\frac{1}{2}} x_{k+1}\|^2 + \|e_k\|^2 \leq \beta^2 \left(\|D_1^{\frac{1}{2}} x_k\|^2 + \|d_k\|^2 \right)$$

Let c_1 and c_2 be the square roots of the maximum and minimum singular values of D_1 . Summing and taking limits yields the final result. \ddagger

Unfortunately, this test (like the SS μ) does not scale in a convenient manner. In other words, if there is a $D_S \in \mathbf{D}_S$ such that $\bar{\sigma}\left(D_S^{\frac{1}{2}} M D_S^{-\frac{1}{2}}\right) = 1.001$, it is impossible to conclude anything about the robust performance characteristics of this system. It is necessary to scale the perturbation channels and/or disturbance channels (this amounts to scaling rows of M to produce a modified system M_{scl}) until a D_S can be found such that $\bar{\sigma}\left(D_S^{\frac{1}{2}} M_{scl} D_S^{-\frac{1}{2}}\right) < 1$, and then robust performance with respect to the scaled down uncertainty and performance norm is guaranteed. For example, let $L = \text{diag}\left[I_n, 0.8I_{n_p}, \frac{1}{1.2}I_m\right]$. Suppose that there is a $D_S \in \mathbf{D}_S$ such that $\bar{\sigma}\left(D_S^{\frac{1}{2}} L M D_S^{-\frac{1}{2}}\right) < 1$. Then it is possible to conclude that for perturbations satisfying $\bar{\sigma}(\Delta_k) \leq 0.8$, the error is bounded by, $\|e\|_2^2 \leq (1.2)^2 \|d\|_2^2 + c_1 \|x_0\|^2$.

Since FDUB is a weaker condition than the SSUB, it is “closer” to the exact condition for robust performance under linear, time-invariant perturbations. Therefore, if the perturbations are better modelled as linear, time-invariant perturbations, this frequency domain test is more appropriate. Also, this test scales, that is, if

$$\max_{\theta \in [0, 2\pi]} \inf_{D_P \in \mathbf{D}_P} \bar{\sigma}\left[D_P^{\frac{1}{2}} \mathcal{S}\left(e^{j\theta} I_n, M\right) D_P^{-\frac{1}{2}}\right] = \beta$$

then the conclusion is that for all $\Delta \in \mathbf{\Delta}$, with $\bar{\sigma}(\Delta) < \frac{1}{\beta}$, the perturbed system is stable, and the $\|\cdot\|_\infty$ norm of the transfer function from the disturbance to error is $\leq \beta$. Hence, peak values other than 1 still give useful information.

However, if the frequency domain test is used, no general conclusion can we reached about time-varying perturbations, (Packard and Doyle, 1990). In (Safonov, 1984), some connections between the frequency domain test and robust stability to cone bounded nonlinearities are developed.

For reference, continuous-time versions of these theorems, as well as theorems with more sophisticated assumptions about the structured perturbations are found in (Chen and Desoer, 1982), (Doyle, Wall, et al, 1982), (Foo and Postlethwaite, 1988), (Khargonekar and Kaminer, 1991), and (Bamieh and Dahleh, 1992).

10.4 \mathcal{H}_∞ norms, Riccati Equations, and LMIs

We now consider the relationship between the bounds given above and Riccati equations for computing the \mathcal{H}_∞ norm of the discrete time system

$$\begin{aligned} x_{k+1} &= Ax_k + Bu_k \\ y_k &= Cx_k + Du_k \end{aligned}$$

Let $M \in \mathbf{C}^{(n+m) \times (n+m)}$ be the block state space matrix of the system

$$M = \begin{bmatrix} A & B \\ C & D \end{bmatrix}$$

Assume that A is stable ($\rho(A) < 1$) and define

$$\begin{aligned} E &:= A + B(I - D'D)^{-1}D'C \\ G &:= -B(I - D'D)^{-1}B' \\ Q &:= C'(I - DD')^{-1}C \end{aligned}$$

Suppose E is nonsingular and define a symplectic matrix as

$$S := \begin{bmatrix} E + GE'^{-1}Q & -GE'^{-1} \\ -E'^{-1}Q & E'^{-1} \end{bmatrix}$$

It can be shown that the following statements are equivalent:

- (a) $\|D + C(zI_n - A)^{-1}B\|_\infty < 1$
- (b) S has no eigenvalues on the unit circle and $\|C(I - A)^{-1}B + D\| < 1$
- (e) $\exists X \geq 0$ with $I - D'D - B'XB > 0$, $(I + GX)^{-1}E$ stable, and

$$E'XE - X - E'XG(I + XG)^{-1}XE + Q = 0$$

- (f) $\exists X > 0$ such that $I - D'D - B'XB > 0$ and

$$E'XE - X - E'XG(I + XG)^{-1}XE + Q < 0$$

- (g) $\exists X > 0$ such that

$$\begin{bmatrix} A & B \\ C & D \end{bmatrix}' \begin{bmatrix} X & 0 \\ 0 & I \end{bmatrix} \begin{bmatrix} A & B \\ C & D \end{bmatrix} - \begin{bmatrix} X & 0 \\ 0 & I \end{bmatrix} < 0$$

- (h) $\exists T$ nonsingular such that

$$\bar{\sigma} \left(\begin{bmatrix} TAT^{-1} & TB \\ CT^{-1} & D \end{bmatrix} \right) = \bar{\sigma} \left(\begin{bmatrix} T & 0 \\ 0 & I \end{bmatrix} \begin{bmatrix} A & B \\ C & D \end{bmatrix} \begin{bmatrix} T & 0 \\ 0 & I \end{bmatrix}^{-1} \right) < 1$$

Note that (e) is a Riccati equation, and the SSUB in (h) is equal to μ because of the block structure. It is equivalent to (g), which is 2 LMIs. The connection between (f) and (g) is just the Schur complement formula for positive definite matrices.

11 Quadratic Lyapunov functions for uncertain systems

Some computable results on the quadratic stability of linear systems under structured, linear fractional uncertainty are possible. Again, consider positive integers n and m , and suppose

$M \in \mathbf{C}^{(n+m) \times (n+m)}$. Let $\mathbf{\Delta}$ be a structured perturbation set with $\mathbf{\Delta} \subset \mathbf{C}^{m \times m}$. Assume that $\mu_{\mathbf{\Delta}}(M_{22}) < 1$, so that $\mathcal{S}(M, \Delta)$ is well defined for all $\Delta \in \mathbf{B}_{\mathbf{\Delta}}$.

Let $\{\Delta_k\}_{k=0}^{\infty}$ with $\Delta_k \in \mathbf{B}_{\mathbf{\Delta}}$ be given, along with an initial condition $x_0 \in \mathbf{C}^n$, define $x_k \in \mathbf{C}^n$ by the uncertain difference equation

$$x_{k+1} = \mathcal{S}(M, \Delta_k) x_k. \quad (11.1)$$

In this formulation, the matrix M_{11} may be thought of as a nominal state space model and $\Delta_k \in \mathbf{B}_{\mathbf{\Delta}}$ as a norm bounded perturbation from an allowable perturbation class, $\mathbf{\Delta}$. The matrices M_{12} , M_{21} , and M_{22} reflect prior knowledge on how the unknown perturbation affects the nominal dynamics, M_{11} .

Definition 11.1 *The pair $(M, \mathbf{\Delta})$ is quadratically stable if there exists a $P \in \mathbf{C}^{n \times n}$, with $P = P^* > 0$, such that*

$$\max_{\Delta \in \mathbf{B}_{\mathbf{\Delta}}} \lambda_{\max}([\mathcal{S}(M, \Delta)]^* P \mathcal{S}(M, \Delta) - P) < 0$$

The definition simply implies that there is a single quadratic Lyapunov function, $V(x) := x^* P x$, that establishes the stability of the entire set

$$\{\mathcal{S}(M, \Delta) : \Delta \in \mathbf{B}_{\mathbf{\Delta}}\}$$

Equivalently, the definition implies that there is a positive definite $P \in \mathbf{C}^{n \times n}$ such that

$$\max_{\Delta \in \mathbf{B}_{\mathbf{\Delta}}} \bar{\sigma}\left(P^{\frac{1}{2}} \mathcal{S}(M, \Delta) P^{-\frac{1}{2}}\right) = \gamma < 1$$

Hence, with respect to a single coordinate change defined by $P^{\frac{1}{2}}$, $\mathcal{S}(M, \Delta_k)$ is *always* a contraction, regardless of $\Delta_k \in \mathbf{B}_{\mathbf{\Delta}}$. As the uncertain system in (11.1) evolves, the Euclidean norm of $P^{\frac{1}{2}} x_k$, $\|P^{\frac{1}{2}} x_k\|_2$, decreases by at least a factor of γ every time step k , and hence robustness with respect to time varying perturbations is guaranteed. Note that if both M is real, and $\mathbf{\Delta} \subset \mathbf{R}^{m \times m}$, then by using an argument similar to that in Theorem 9.10, the matrix P , if it exists, will also be real.

Using Theorem 4.10 and the fact that in *some* instances (when $2S + F \leq 3$), μ and the upper bound are always equal, we can establish necessary and sufficient conditions for a pair to be quadratically stable, in terms of a scaled state-space test, and/or a scaled \mathcal{H}_{∞} norm test. Several cases are outlined below, along with a chain of equivalences which produces the result. As usual, define the transfer function $G(z)$ as

$$G(z) := M_{22} + M_{21}(zI - M_{11})^{-1} M_{12}.$$

Note that this is the transfer function of the linear system that the perturbation Δ_k “sees.”

11.1 Real state-space data, 1 full real perturbation

Suppose that $M \in \mathbf{R}^{(n+m) \times (n+m)}$, and that $\mathbf{\Delta} = \mathbf{R}^{m \times m}$. Assume that $\bar{\sigma}(M_{22}) < 1$. For any $P \in \mathbf{C}^{n \times n}$ with $P = P^* > 0$, let

$$M^P := \begin{bmatrix} P^{\frac{1}{2}} M_{11} P^{-\frac{1}{2}} & P^{\frac{1}{2}} M_{12} \\ M_{21} P^{-\frac{1}{2}} & M_{22} \end{bmatrix}.$$

Also, define

$$\Delta_R := \{\text{diag}[\Delta_1, \Delta_2] : \Delta_1 \in \mathbf{R}^{n \times n}, \Delta_2 \in \mathbf{R}^{m \times m}\}.$$

Then, using Theorem 4.3 and the results from sections 9.7 and 10, the following statements are equivalent:

1. There exists $P \in \mathbf{C}^{n \times n}, P = P^* > 0$ such that $\max_{\Delta \in \mathbf{B}_\Delta} \bar{\sigma} \left[P^{\frac{1}{2}} \mathcal{S}(M, \Delta) P^{-\frac{1}{2}} \right] < 1$
2. There exists $P \in \mathbf{R}^{n \times n}, P = P^T > 0$ such that $\max_{\Delta \in \mathbf{B}_\Delta} \bar{\sigma} \left[P^{\frac{1}{2}} \mathcal{S}(M, \Delta) P^{-\frac{1}{2}} \right] < 1$
3. $\inf_{\substack{P \in \mathbf{R}^{n \times n} \\ P = P^T > 0}} \max_{\Delta \in \mathbf{B}_\Delta} \bar{\sigma} \left[\mathcal{S}(M^P, \Delta) \right] < 1$
4. $\inf_{\substack{P \in \mathbf{R}^{n \times n} \\ P = P^T > 0}} \mu_{\Delta_R}(M^P) < 1$
5. $\inf_{\substack{P \in \mathbf{R}^{n \times n} \\ P = P^T > 0}} \inf_{d_1 > 0} \bar{\sigma} \left(\begin{bmatrix} \sqrt{d_1} & 0 \\ 0 & I_m \end{bmatrix} M^P \begin{bmatrix} \frac{1}{\sqrt{d_1}} & 0 \\ 0 & I_m \end{bmatrix} \right) < 1$
6. $\inf_{\substack{P \in \mathbf{R}^{n \times n} \\ P = P^T > 0}} \inf_{d_1 > 0} \bar{\sigma} \left(\begin{bmatrix} \sqrt{d_1} P^{\frac{1}{2}} & 0 \\ 0 & I_m \end{bmatrix} M \begin{bmatrix} \frac{1}{\sqrt{d_1}} P^{-\frac{1}{2}} & 0 \\ 0 & I_m \end{bmatrix} \right) < 1$
7. $\inf_{\substack{P \in \mathbf{R}^{n \times n} \\ P = P^T > 0}} \bar{\sigma} \left(\begin{bmatrix} P^{\frac{1}{2}} & 0 \\ 0 & I_m \end{bmatrix} M \begin{bmatrix} P^{-\frac{1}{2}} & 0 \\ 0 & I_m \end{bmatrix} \right) < 1$
8. $\rho(M_{11}) < 1$ and $\|G\|_\infty < 1$

The main point here is that the uncertain system is quadratically stable with respect to full block, norm bounded, real perturbations (condition 1) if and only the \mathcal{H}_∞ norm of the transfer function that the perturbation sees is less than 1 (condition 8). Conditions 2-7 are intermediate steps which link the two conditions together. This same style is used in Sections 11.2-11.4.

11.2 Complex state-space data, 1 full complex perturbation

Suppose that $M \in \mathbf{C}^{(n+m) \times (n+m)}$, and that $\Delta = \mathbf{C}^{m \times m}$. Assume that $\bar{\sigma}(M_{22}) < 1$. For any $P \in \mathbf{C}^{n \times n}$ with $P = P^* > 0$, let

$$M^P := \begin{bmatrix} P^{\frac{1}{2}} M_{11} P^{-\frac{1}{2}} & P^{\frac{1}{2}} M_{12} \\ M_{21} P^{-\frac{1}{2}} & M_{22} \end{bmatrix}.$$

Also, define

$$\Delta_C := \{\text{diag}[\Delta_1, \Delta_2] : \Delta_1 \in \mathbf{C}^{n \times n}, \Delta_2 \in \mathbf{C}^{m \times m}\}.$$

Then, using Theorem 4.3 and the results from sections 9.1 and 10, the following statements are equivalent:

1. There exists $P \in \mathbf{C}^{n \times n}, P = P^* > 0$ such that $\max_{\Delta \in \mathbf{B}_\Delta} \bar{\sigma} \left[P^{\frac{1}{2}} \mathcal{S}(M, \Delta) P^{-\frac{1}{2}} \right] < 1$
2. $\inf_{\substack{P \in \mathbf{C}^{n \times n} \\ P = P^* > 0}} \max_{\Delta \in \mathbf{B}_\Delta} \bar{\sigma} \left[\mathcal{S}(M^P, \Delta) \right] < 1$
3. $\inf_{\substack{P \in \mathbf{C}^{n \times n} \\ P = P^* > 0}} \mu_{\Delta_C} (M^P) < 1$
4. $\inf_{\substack{P \in \mathbf{C}^{n \times n} \\ P = P^* > 0}} \inf_{d_1 > 0} \bar{\sigma} \left(\begin{bmatrix} \sqrt{d_1} & 0 \\ 0 & I_m \end{bmatrix} M^P \begin{bmatrix} \frac{1}{\sqrt{d_1}} & 0 \\ 0 & I_m \end{bmatrix} \right) < 1$
5. $\inf_{\substack{P \in \mathbf{C}^{n \times n} \\ P = P^* > 0}} \inf_{d_1 > 0} \bar{\sigma} \left(\begin{bmatrix} \sqrt{d_1} P^{\frac{1}{2}} & 0 \\ 0 & I_m \end{bmatrix} M \begin{bmatrix} \frac{1}{\sqrt{d_1}} P^{-\frac{1}{2}} & 0 \\ 0 & I_m \end{bmatrix} \right) < 1$
6. $\inf_{\substack{P \in \mathbf{C}^{n \times n} \\ P = P^* > 0}} \bar{\sigma} \left(\begin{bmatrix} P^{\frac{1}{2}} & 0 \\ 0 & I_m \end{bmatrix} M \begin{bmatrix} P^{-\frac{1}{2}} & 0 \\ 0 & I_m \end{bmatrix} \right) < 1$
7. $\rho(M_{11}) < 1$ and $\|G\|_\infty < 1$

Some interesting connections between different notions of stability can be made at this point. To do so, consider the definition of **robust stability** given below:

Definition 11.2 *The pair (M, Δ) is robustly stable if*

$$\max_{\Delta \in \mathbf{B}_\Delta} \rho(\mathcal{S}(M, \Delta)) < 1.$$

Recall the example in section 4, which demonstrated an application of the Main Loop theorem. In that example, LFT arguments were given to prove that the pair $(M, \mathbf{C}^{m \times m})$ is robustly stable if and only if $\|G\|_\infty < 1$, where $G(z) = M_{22} + M_{21}(zI_n - M_{11})^{-1}M_{12}$. That result, along with section 11.1 and this section combine to form the following theorem, (Willems, 1973), (Popov, 1962), (Khargonekar, Petersen, et al, 1990):

Theorem 11.3 *Suppose that $M \in \mathbf{R}^{(n+m) \times (n+m)}$, with $\bar{\sigma}(M_{22}) < 1$. Define $G(z) := M_{22} + M_{21}(zI_n - M_{11})^{-1}M_{12}$. Then, the conditions*

1. *The pair $(M, \mathbf{R}^{m \times m})$ is quadratically stable*
2. *The pair $(M, \mathbf{C}^{m \times m})$ is quadratically stable*
3. *The pair $(M, \mathbf{C}^{m \times m})$ is robustly stable*
4. *$\rho(M_{11}) < 1$, and $\|G\|_\infty < 1$*

are equivalent.

It is important to note that conditions (1) and (3) become incomparable (neither implies the other) when the perturbation set becomes structured, (Packard and Doyle, 1990), (Rotea, Corless, et al, 1991).

11.3 Complex state-space data, 1 repeated complex perturbation

Suppose $M \in \mathbf{C}^{(n+m) \times (n+m)}$ and $\Delta = \{\delta I_m : \delta \in \mathbf{C}\}$. Let Δ_S be defined as

$$\Delta_S := \{\text{diag}[\Delta_1, \delta_2 I_m] : \Delta_1 \in \mathbf{C}^{n \times n}, \delta_2 \in \mathbf{C}\}$$

Then, using Theorem 4.3 and the results from sections 9.4 and 10, the following statements are equivalent:

1. There exists $P \in \mathbf{C}^{n \times n}, P = P^* > 0$ such that $\max_{\substack{\delta_2 \in \mathbf{C} \\ |\delta_2| \leq 1}} \bar{\sigma} \left[P^{\frac{1}{2}} \mathcal{S}(M, \delta_2 I_m) P^{-\frac{1}{2}} \right] < 1$
2. $\inf_{\substack{P \in \mathbf{C}^{n \times n} \\ P = P^* > 0}} \max_{\substack{\delta_2 \in \mathbf{C} \\ |\delta_2| \leq 1}} \bar{\sigma} \left[\mathcal{S}(M^P, \delta_2 I_m) \right] < 1$
3. $\inf_{\substack{P \in \mathbf{C}^{n \times n} \\ P = P^* > 0}} \mu_{\Delta_S}(M^P) < 1$
4. $\inf_{\substack{P \in \mathbf{C}^{n \times n} \\ P = P^* > 0}} \inf_{\substack{D_2 \in \mathbf{C}^{m \times m} \\ D_2 = D_2^* > 0}} \bar{\sigma} \left(\begin{bmatrix} I_n & 0 \\ 0 & D_2^{\frac{1}{2}} \end{bmatrix} M^P \begin{bmatrix} I_n & 0 \\ 0 & D_2^{-\frac{1}{2}} \end{bmatrix} \right) < 1$
5. $\inf_{\substack{P \in \mathbf{C}^{n \times n} \\ P = P^* > 0}} \inf_{\substack{D_2 \in \mathbf{C}^{m \times m} \\ D_2 = D_2^* > 0}} \bar{\sigma} \left(\begin{bmatrix} P^{\frac{1}{2}} & 0 \\ 0 & D_2^{\frac{1}{2}} \end{bmatrix} M \begin{bmatrix} P^{-\frac{1}{2}} & 0 \\ 0 & D_2^{-\frac{1}{2}} \end{bmatrix} \right) < 1$
6. $\rho(M_{11}) < 1$ and $\inf_{\substack{D_2 \in \mathbf{C}^{m \times m} \\ D_2 = D_2^* > 0}} \left\| D_2^{\frac{1}{2}} G D_2^{-\frac{1}{2}} \right\|_{\infty} < 1$

In this section, the matrix $\mathcal{S}(M, \delta I_m)$ is a rational function of the scalar, complex parameter δ . We have shown that quadratic stability with respect to such a parameter can be ascertained by determining if the convex set

$$\left\{ X = \begin{bmatrix} P & 0 \\ 0 & D_2 \end{bmatrix} : P \in \mathbf{C}^{n \times n}, D_2 \in \mathbf{C}^{m \times m}, X = X^* > 0, M^* X M - X < 0 \right\}$$

is nonempty.

11.4 Complex state-space data, 2 complex full blocks

Suppose that $M \in \mathbf{C}^{(n+m) \times (n+m)}$, and Δ is

$$\Delta := \{\text{diag}[\Delta_1, \Delta_2] : \Delta_i \in \mathbf{C}^{m_i \times m_i}\} \subset \mathbf{C}^{m \times m}$$

and let

$$\Delta_C := \{\text{diag}[\Delta_0, \Delta] : \Delta_0 \in \mathbf{C}^{n \times n}, \Delta \in \Delta\}$$

Then, using Theorem 4.3 and the results from sections 9.3 and 10, the following statements are equivalent:

1. There exists $P \in \mathbf{C}^{n \times n}, P = P^* > 0$ such that $\max_{\Delta \in \mathbf{B}_\Delta} \bar{\sigma} \left[P^{\frac{1}{2}} \mathcal{S}(M, \Delta) P^{-\frac{1}{2}} \right] < 1$
2. $\inf_{\substack{P \in \mathbf{C}^{n \times n} \\ P = P^* > 0}} \max_{\Delta \in \mathbf{B}_\Delta} \bar{\sigma} \left[\mathcal{S}(M^P, \Delta) \right] < 1$
3. $\inf_{\substack{P \in \mathbf{C}^{n \times n} \\ P = P^* > 0}} \mu_{\Delta_C}(M^P) < 1$
4. $\inf_{\substack{P \in \mathbf{C}^{n \times n} \\ P = P^* > 0}} \inf_{d_1, d_2 > 0} \bar{\sigma} \left(\begin{bmatrix} \sqrt{d_1} I_n & 0 & 0 \\ 0 & \sqrt{d_2} I_{m_1} & 0 \\ 0 & 0 & I_{m_2} \end{bmatrix} M^P \begin{bmatrix} \frac{1}{\sqrt{d_1}} I_n & 0 & 0 \\ 0 & \frac{1}{\sqrt{d_2}} I_{m_1} & 0 \\ 0 & 0 & I_{m_2} \end{bmatrix} \right) < 1$
5. $\inf_{\substack{P \in \mathbf{C}^{n \times n} \\ P = P^* > 0}} \inf_{d_1, d_2 > 0} \bar{\sigma} \left(\begin{bmatrix} \sqrt{d_1} P^{\frac{1}{2}} & 0 & 0 \\ 0 & \sqrt{d_2} I_{m_1} & 0 \\ 0 & 0 & I_{m_2} \end{bmatrix} M \begin{bmatrix} \frac{1}{\sqrt{d_1}} P^{-\frac{1}{2}} & 0 & 0 \\ 0 & \frac{1}{\sqrt{d_2}} I_{m_1} & 0 \\ 0 & 0 & I_{m_2} \end{bmatrix} \right) < 1$
6. $\inf_{\substack{P \in \mathbf{C}^{n \times n} \\ P = P^* > 0}} \inf_{d_2 > 0} \bar{\sigma} \left(\begin{bmatrix} P^{\frac{1}{2}} & 0 & 0 \\ 0 & \sqrt{d_2} I_{m_1} & 0 \\ 0 & 0 & I_{m_2} \end{bmatrix} M \begin{bmatrix} P^{-\frac{1}{2}} & 0 & 0 \\ 0 & \frac{1}{\sqrt{d_2}} I_{m_1} & 0 \\ 0 & 0 & I_{m_2} \end{bmatrix} \right) < 1$
7. $\rho(M_{11}) < 1$ and

$$\inf_{d_2 > 0} \left\| \begin{bmatrix} \sqrt{d_2} I_{m_1} & 0 \\ 0 & I_{m_2} \end{bmatrix} G \begin{bmatrix} \frac{1}{\sqrt{d_2}} I_{m_1} & 0 \\ 0 & I_{m_2} \end{bmatrix} \right\|_\infty < 1$$

Hence quadratic stability with respect to two full complex blocks of uncertainty is equivalent to an optimally scaled small gain condition. Note that for any $\alpha > 0$,

$$\left\{ d_2 > 0 : \left\| \begin{bmatrix} \sqrt{d_2} I_{m_1} & 0 \\ 0 & I_{m_2} \end{bmatrix} G \begin{bmatrix} \frac{1}{\sqrt{d_2}} I_{m_1} & 0 \\ 0 & I_{m_2} \end{bmatrix} \right\|_\infty < \alpha \right\}$$

is either empty or is a convex set (an interval).

11.5 Conclusions

Some of these results are well-known, and available in the literature, although the treatment here is more unified. The results relating quadratic stability and $\|\cdot\|_\infty$ for full block perturbations (sections 11.1 and 11.2) are proven for SISO systems in (Popov, 1962), (Willems, 1973), and for MIMO systems in (Khargonekar, Petersen, et al, 1990). The results for 2 complex blocks is from (Packard and Doyle, 1990), while the result for a single complex repeated scalar perturbation, is, to our knowledge, new. Similar results are easily derived for continuous-time systems, using a bilinear transform. By defining

$$\mathcal{B} := \begin{bmatrix} I_n & \sqrt{2} I_n \\ \sqrt{2} I_n & I_n \end{bmatrix},$$

and noting that

$$\begin{aligned} A^*P + PA < 0 &\leftrightarrow P^{-\frac{1}{2}}A^*P^{\frac{1}{2}} + P^{\frac{1}{2}}AP^{-\frac{1}{2}} < 0 \\ &\leftrightarrow \bar{\sigma}\left(\mathcal{S}\left(\mathcal{B}, P^{\frac{1}{2}}AP^{-\frac{1}{2}}\right)\right) < 1 \\ &\leftrightarrow \bar{\sigma}\left(P^{\frac{1}{2}}\mathcal{S}(\mathcal{B}, A)P^{-\frac{1}{2}}\right) < 1 \end{aligned}$$

the results relating $\|\cdot\|_\infty$ (possibly a scaled norm, as in sections 11.4 and 11.3) and quadratic stability can be derived in the same manner.

12 μ -Synthesis via Optimally Scaled LFTs

This paper so far has only considered μ -analysis. The problem of μ -synthesis is much more difficult, and will be discussed in this section. In general, μ -synthesis methods have focused on minimizing μ of some rational matrix over stabilizing controllers using the frequency-domain upper bound (FDUB) and have been successfully used in many applications. Nevertheless, the theoretical basis for μ -synthesis is much weaker than for μ -analysis. This section will consider a μ -synthesis problem involving only constant matrices, to explore the potential difficulties in a simple setting. For an introduction to μ -synthesis in the rational case, see (Balas, Doyle, et al, 1991).

Suppose that a matrix M depends on a free parameter Q . How can Q be found so as to minimize $\mu_\Delta(M)$? In this section we consider this problem when M depends on a free matrix Q in a linear fractional manner, and we attempt to minimize the upper bound for $\mu_\Delta(M)$, rather than $\mu_\Delta(M)$ itself. This problem is first reduced to an affine, rather than linear fractional, transformation, and then partially solved using an elementary extension to matrix dilation theory (Davis, Kahan, et al, 1982), (Power, 1982). In the lemmas to follow, \mathbf{F} denotes either the real or complex field.

Lemma 12.1 *Let $R \in \mathbf{F}^{n \times n}$, $U \in \mathbf{F}^{n \times r}$, $T \in \mathbf{F}^{t \times r}$, and $V \in \mathbf{F}^{t \times n}$, where $r, t \leq n$. Let $\mathcal{Z} \subset \mathbf{F}^{n \times n}$ be a prescribed set of positive definite matrices. Then*

$$\inf_{\substack{Q \in \mathbf{F}^{r \times t}, Z \in \mathcal{Z} \\ \det(I - TQ) \neq 0}} \bar{\sigma}\left[Z^{\frac{1}{2}}\left(R + UQ(I - TQ)^{-1}V\right)Z^{-\frac{1}{2}}\right] = \inf_{\substack{\tilde{Q} \in \mathbf{F}^{r \times t}, Z \in \mathcal{Z}}} \bar{\sigma}\left[Z^{\frac{1}{2}}\left(R + U\tilde{Q}V\right)Z^{-\frac{1}{2}}\right]$$

Proof: For any $T \in \mathbf{F}^{t \times r}$, the closure of the set

$$\left\{Q(I - TQ)^{-1} : Q \in \mathbf{F}^{r \times t}, \det(I - TQ) \neq 0\right\}$$

is all of $\mathbf{F}^{r \times t}$, which shows that the infimums are the same. \ddagger

Hence, in order to solve general linear fractional transformation optimization problems, only affine transformations need be considered. We also assume (without loss in generality) that U is full column rank, and that V is full row rank. The first lemma addresses the unscaled problem, and comes from (Davis, Kahan, et al, 1982), (Power, 1982):

Lemma 12.2 *Let R, U, V , be given as above. Suppose $U_{\perp} \in \mathbf{F}^{n \times (n-r)}$ and $V_{\perp} \in \mathbf{F}^{(n-t) \times n}$ are chosen such that $\begin{bmatrix} U & U_{\perp} \end{bmatrix}, \begin{bmatrix} V \\ V_{\perp} \end{bmatrix}$ are both invertible, and that $U^*U_{\perp} = 0_{r \times (n-r)}, VV_{\perp}^* = 0_{t \times (n-t)}$. Let $\alpha > 0$. Then*

$$\inf_{Q \in \mathbf{F}^{r \times t}} \bar{\sigma} [(R + UQV)] < \alpha$$

if and only if

$$\begin{aligned} \lambda_{\max} [V_{\perp} (R^*R - \alpha^2 I) V_{\perp}^*] &< 0 \\ \lambda_{\max} [U_{\perp}^* (RR^* - \alpha^2 I) U_{\perp}] &< 0 \end{aligned} \quad (12.1)$$

The next lemma partially answers the synthesis question when similarity scalings are included. The proof is in (Doyle, 1985(a)) and (Packard, Zhou, et al, 1992).

Lemma 12.3 *Let R, U, V, U_{\perp} and V_{\perp} be given as above. Let $\alpha > 0$ and $\mathbf{Z} \subset \mathbf{F}^{n \times n}$ be a given set of positive definite, Hermitian matrices. Then*

$$\inf_{\substack{Q \in \mathbf{F}^{r \times t} \\ Z \in \mathbf{Z}}} \bar{\sigma} \left[Z^{\frac{1}{2}} (R + UQV) Z^{-\frac{1}{2}} \right] < \alpha$$

if and only if there is a $Z \in \mathbf{Z}$ such that

$$\lambda_{\max} [V_{\perp} (R^*ZR - \alpha^2 Z) V_{\perp}^*] < 0 \quad (12.2)$$

and

$$\lambda_{\max} [U_{\perp}^* (RZ^{-1}R^* - \alpha^2 Z^{-1}) U_{\perp}] < 0. \quad (12.3)$$

Note that the condition imposed on Z in equation (12.2), is convex, therefore, if the set \mathbf{Z} is itself convex, determining solutions of equation (12.2) is a convex feasibility problem. Similarly, the condition imposed on Z^{-1} in equation (12.3) is convex in Z^{-1} , so if the set \mathbf{Z}^{-1} is convex, this is also a convex feasibility problem. The convexity of these “one-sided” problems is exploited in (Packard, Zhou, et al, 1992) and (Packard, Zhou, et al, 1991), where some robust control problems are formulated, and recast as convex optimizations, using this scaled linear fractional transformation approach. Unfortunately, the complete problem, which involves both Z and Z^{-1} conditions, is more difficult, and at the moment, unsolved. In some special cases, it may be possible to obtain computable necessary and sufficient conditions. For instance, if

$$\mathbf{Z} = \left\{ \begin{bmatrix} z_1 I_{n_1} & 0 \\ 0 & I_{n_2} \end{bmatrix} : z_1 > 0 \right\},$$

then both conditions define open intervals in the real line, and it is easy to check if these intervals intersect (moreover, the intersection is either empty or convex). More generally though, the set of “good Z ’s” may be a disconnected set. Specifically, given matrices R, U and V , and $\alpha > 0$, let \mathbf{Z}_{good} be

$$\mathbf{Z}_{\text{good}}(\alpha) := \left\{ Z \in \mathbf{Z} : \inf_{Q \in \mathcal{M}(\mathbf{C})} \bar{\sigma} \left(Z^{\frac{1}{2}} (R + UQV) Z^{-\frac{1}{2}} \right) < \alpha \right\}$$

It is this set, $\mathbf{Z}_{\text{good}}(\alpha)$, which may be disconnected. In particular, let $\alpha := 1$, and

$$\mathbf{Z} = \{ \text{diag} [z_1, z_2, 1] : z_1 > 0, z_2 > 0 \},$$

and define matrices

$$R = \begin{bmatrix} 1 & -1 & 0 \\ -1 & 1 & 10\sqrt{2} \\ 0 & \sqrt{2} & 0 \end{bmatrix}, \quad U = V^T = \begin{bmatrix} \frac{1}{\sqrt{2}} & 0 \\ \frac{-1}{\sqrt{2}} & 0 \\ 0 & 1 \end{bmatrix}$$

Applying the formulae, we have that $Z \in \mathbf{Z}_{\text{good}}$ if and only if $z_i > 0$, $z_1 + z_2 > 2$, and $\frac{1}{z_1} + \frac{1}{z_2} > 200$. Clearly, the region of good Z 's in the z_1 - z_2 plane consists of two slivers near the axis, which is not a connected set. Unlike the analysis problem the level sets of scalings in the synthesis problem are not convex. We are currently investigating the implications of this property.

13 Summary of some related work

This section outlines some work related to this paper, beginning with a brief history of the early development of the μ theory. This outline is not intended to be exhaustive or complete, but simply to touch on a few of the topics nearest to this paper that were not considered in detail. LMIs are discussed as potentially unifying theoretical and computational tools. The relationship between μ and quadratic versus L_1 notions of robust performance and robust stability is considered next, followed by μ with mixed real and complex perturbations. The section ends with model validation and generalizations of μ .

13.1 History of early work

In this section, we will briefly review the ideas that most influenced the original development of the μ theory. These remarks are drawn mainly from earlier papers ((Doyle, 1982), (Doyle, Wall, et al, 1982), and (Fan, Tits, et al, 1991)), but are repeated here for the convenience of the reader.

An obvious influence on the development of the μ theory was the work in so-called Robust Multivariable Control Systems from the late '70s, (See, for example, [IEEE]) which in turn drew heavily on earlier work in stability analysis (e.g. (Zames, 1965), (Desoer and Vidyasagar, 1975), (Willems, 1971b), (Safonov, 1980)), particularly the small gain and circle theorems. These theorems established sufficient conditions for stability of nonlinear components connected in feedback. The emphasis in the early robustness work was on small gain type conditions involving singular values that were *both* necessary and sufficient for stability of *sets* of linear systems involving a single norm bounded but otherwise unconstrained perturbation. Another emphasis for much of the robustness theory was on using singular value plots as a means of generalizing Bode magnitude plots to multivariable systems.

While methods based on singular values were gaining in popularity, it became evident that their assumption of unstructured uncertainty was too crude for many applications. Furthermore, the problem of robust performance was not adequately treated. Freudenberg, Looze, et al (1982) studied these issues using differential sensitivity and suggested that something more than singular values was needed. It was a natural step to introduce structured uncertainty of the type considered in this paper (see (Safonov, 1978) for an early treatment). The so-called conservativeness of singular values was based the fact that the unscaled bounds $\rho(M) \leq \mu_{\Delta}(M) \leq \bar{\sigma}(M)$

could be arbitrarily far off, and research was begun to provide improved estimates of μ , with an initial focus on the nonrepeated, complex case ($S = 0$).

It was obvious that the sharper bounds

$$\max_{Q \in \mathbf{Q}} \rho(QM) \leq \max_{\Delta \in \mathbf{B}\Delta} \rho(\Delta M) = \mu_{\Delta}(M) \leq \inf_{D \in \mathbf{D}} \bar{\sigma} \left(D^{\frac{1}{2}} M D^{-\frac{1}{2}} \right) \quad (13.1)$$

could help alleviate the conservativeness somewhat. The upper bound is similar to the multiplier methods that were used in nonlinear stability analysis to reduce the conservativeness of small gain type methods (Willems, 1971b), but the use of both upper and lower bounds, and the questions of how close the bounds were and how to efficiently compute them were new and open. As we saw in Section 6, the equality of the lower bound and μ is relatively straightforward and not surprising. What is remarkable, even in retrospect, is that the upper bound is often close to μ and is in fact equal to μ for certain simple block structures.

There was substantial numerical evidence for the upper bound results before they were proven. Engineers at Honeywell's Systems and Research Center, particularly Joe Wall, began routinely using a simple generalization of Osborne's routine (Osborne, 1960) to approximate the upper bound in (13.1) and gradient search methods to find a local maximum for the lower bound. Osborne's algorithm minimizes the Frobenius norm rather than the maximum singular value, and the scalings produced can be used to approximate the upper bound. The consistent closeness of the bounds, usually within a few percent, suggested that there was a deeper connection between the bounds. Ironically, minimizing the Frobenius norm remains the cheapest method of approximating the upper bound. Safonov (1982) suggested a somewhat less general approximation to the upper bound based on Perron eigenvectors which is comparable to Osborne in speed and accuracy.

While the μ framework arises naturally in studying robust stability with structured uncertainty, the use of μ to treat directly the problem of robust *performance* with structured uncertainty was first explicitly noted in (Doyle, Wall, et al, 1982). As noted above, this is a consequence of the intimate connection between μ and LFTs (Doyle, 1985(b), and Packard, 1988). In retrospect, it is clear that Redheffer (1959 and 1960) had developed the foundation of this connection in his work on LFTs in the late 1950's. In fact, as noted earlier, Redheffer had even proven that the upper bound in (13.1) was an equality for the case where $S = 0$ and $F = 2$. While Redheffer's results were not well-known in the control community until the μ theory was already well-developed, the rediscovery of his work has since had an important influence, not only on the further development of μ but in other areas as well (e.g. see (Doyle, Glover, et al, 1989)).

13.2 Linear Matrix Inequalities

We have seen in this paper how LMIs arise naturally in both μ analysis and synthesis in the computation of upper bounds. The general LMI problem involves sets of the form

$$\mathcal{X} = \left\{ \begin{array}{l} \text{diag} [X_1, \dots, X_S, x_1 I, \dots, x_F I] : \\ X_i \in \mathbf{C}^{r_i \times r_i}, X_i = X_i^*, x_j \in \mathbf{R} \end{array} \right\} \quad (13.2)$$

and a list of matrices A_i, B_i, C_i, D_i . The simplest general LMI problem is to determine whether there exists $X \in \mathcal{X}$ such that

$$A_i^* X A_i - B_i^* X B_i + X C_i + C_i^* X + D_i < 0 \quad \forall i$$

Depending on the particular problem, the $<$ may be a \leq . It is easy to see that these inequality conditions produce a set of solutions which are convex, which makes LMIs attractive computationally. (In the synthesis problem in Section 12, there are additional constraints that destroy convexity.) This is a decision problem; the answer is yes or no. Sometimes, however, the $A_i, B_i, C_i,$ and D_i are functions of a real, positive parameter α , and we want to know, for example, what is the largest α for which there is no solution. Typically this involves an iteration on α , and consequently, answering the decision question many times.

Recall that the upper bound for μ can be rewritten as an LMI of the form

$$\exists X > 0 : M^* X M - \beta^2 X < 0 \tag{13.3}$$

It has recently been shown that a number of other problems can be reduced to solving LMIs. In (Wang, Doyle, et al, 1991) balanced truncation model reduction is extended to uncertain LFT systems, with similar extensions of the parametrization of all stabilizing controllers in (Lu, Zhou, et al, 1991). The LFT/LMI machinery not only extends the standard results in important ways, it simplifies the proofs, often substantially. Exciting new developments in handling real parametric uncertainty (Young, Newlin, et al, 1991) and model validation (Newlin and Smith, 1991) will be outlined in subsequent subsections. In all cases, LMIs play a central role in computation of solutions. We believe that LMIs will replace Lyapunov and Riccati equations, which are both special cases of LMIs, as the central computational problems in robust control.

The problem of solving LMIs can be viewed in a number of ways, from solving a set of linear equalities to minimizing the eigenvalues of a Hermitian matrix function (Beck, 1991). One of the goals of our current research is to develop fast, reliable algorithms for solving LMIs which are comparable to what is available for solving Riccati and Lyapunov equations. Several researchers have already begun looking at this question.

One approach to solving LMIs is to convert them to eigenvalue optimization problems which results in convex, non-differentiable functions for which numerous optimization methods have been developed. Boyd and Yang (1989) compare the efficiency of two convex programming algorithms, Kelley's cutting-plane algorithm and Shor's subgradient algorithm. Boyd and Yang find Kelley's cutting-plane algorithm to be most effective of the two, since it converges in the fewest number of iterations. An alternative convex programming method which has been used for LMI problems is the ellipsoid method, which is also a cutting-plane method. Although these methods are easy to implement, they are generally too slow to warrant considerable attention.

Overton (1990) studies the optimality conditions, and develops quadratically convergent algorithms for LMI's.

Recently, interior point methods have been applied to LMI problems with favorable results. Interior and exterior point methods are used to convert constrained minimization problems to differentiable, unconstrained minimization problems, to which optimization algorithms such as Newton's method are applied (Nesterov and Nemirovsky, 1989 and 1990). Jarre (1991) has used

an interior point algorithm for a problem similar to LMIs which required substantially fewer iterations than does the cutting-plane algorithm used by Boyd and Yang. A similar approach is taken by Boyd and El Ghaoui (1991). We are currently investigating alternative functions for solving LMIs using both interior and exterior point methods (Beck, 1991).

13.3 μ , \mathcal{Q} , and L_1

We have considered several different measures of robust stability and performance in Section 10 from $\text{SS}\mu$ to the SSUB. We will concentrate on these two measures, and compare them briefly with another very important measure that has emerged in the L_1 theory of robust performance with structured uncertainty. Space constraints preclude a review of the L_1 theory, which has undergone a dramatic and impressive development in the last 5 years in the work of Khammash and Pearson (1991), and Dahleh and Khammash (1991) and references therein. For simplicity, we will refer to the $\text{SS}\mu$ test as μ and the SSUB upper bound as \mathcal{Q} (since it is directly related to quadratic stability), and focus our attention on the robust performance problem, which clearly includes robust stability as a special case.

The μ , \mathcal{Q} , and L_1 tests all guarantee robust performance, but with different assumptions about perturbations and the norm used for measuring the performance objective. The μ and \mathcal{Q} theories are used for L_2 induced norms, while the L_1 theory is used for L_∞ induced norms. A second distinction is that the μ theory treats LTI perturbations, and the \mathcal{Q} and L_1 handle Nonlinear and Time-Varying perturbations (NTV). This is summarized in the table below.

	LTI	NTV
L_2	μ	\mathcal{Q}
L_∞	μ	L_1

The cases on the diagonal, L_2/LTI and L_∞/NTV , are both necessary and sufficient for robust performance. The L_∞/LTI case is necessary and sufficient for robust stability, but the robust performance question is open. The \mathcal{Q} case (L_2/NTV) is sufficient for robust performance, and recent results, obtained independently using very different methods by Shamma and Megretskii, suggest that it is necessary as well. Recall that in general, μ is computed using bounds, but that \mathcal{Q} involves solving LMIs, so is attractive computationally. L_1 is also easy to compute, involving only the evaluation of L_1 norms and finding the spectral radius of a positive matrix (Khammash and Pearson, 1991).

As a final comparison, it can be easily shown that the tests are ordered, with

$$\mu \leq \mathcal{Q} \leq L_1 \tag{13.4}$$

The interpretation of (13.4) for a given system is that if the \mathcal{Q} test passes, the μ test must pass, and similarly for L_1 and \mathcal{Q} . It was shown above that $\mu \leq \mathcal{Q}$. The inequality $\mathcal{Q} \leq L_1$ follows from the equivalence of the SSUB and the FDCD problems, the fact that the L_1 norm of a convolution kernel is greater than the H_∞ norm of its transform, and the results in (Khammash and Pearson, 1991). The inequalities are typically strict and it is possible for the gaps to be arbitrarily large.

It is not clear exactly what the implications of these results are for control design or for further research. Clearly there is a need for more refined results, and the ability to both combine LTI and NTV uncertainty and exploit additional structure such as the slowly-varying nature of some perturbations. The results in (Safonov, 1984), (Packard and Teng, 1990) and (Packard and Zhou, 1989) suggest how this might be done in the LFT/ μ / \mathcal{Q} framework, but much more work is needed. We also need more precise modeling and ID methods to exploit the detailed structure of the uncertainty in our models.

If one accepts \mathcal{Q} as the measure of robust performance, a rich theory can be developed, with generalizations to uncertain systems of the conventional theories of robust stability and performance, balanced realizations and model reduction (Wang, Doyle, et al, 1991), stabilization (Lu, Zhou, et al, 1991), and model validation (Newlin and Smith, 1991). It is not surprising that the easiest generalizations of standard results to uncertain LFT systems is done using the \mathcal{Q} framework. Indeed, most of the standard results rely on \mathcal{Q} machinery, but since μ and \mathcal{Q} are the same for these simple block structures, we are less aware of the distinction. Once we begin extending our results to systems with uncertainty, the distinction becomes significant. Of course, a key feature of the \mathcal{Q} theory is that computation involves solving LMIs.

13.4 μ with real perturbations

In recent years a great deal of interest has arisen with regard to robustness problems involving parametric uncertainty. These problems involve uncertain parameters that are not only norm bounded, but also constrained to be real. Robustness problems involving parametric uncertainty can be reformulated as μ problems where the block structured uncertainty description is now allowed to contain both real and complex blocks. This mixed μ problem can have fundamentally different properties from the complex μ problem studied in this paper (where the block structured uncertainty description contains only complex blocks), and these properties have important implications for computation. In this section we give a brief review of some recent results in this area.

It is now well known that real μ problems can be discontinuous in the problem data (see (Barmish, Khargonekar, et al, 1989)). As well as adding computational difficulties to the problem this sheds serious doubt on the usefulness of real μ as a robustness measure in such cases, since the system model is always a mathematical abstraction from the real world, and is computed to finite precision. However it is shown in (Packard and Pandey, 1991) that mixed μ problems containing some complex uncertainty are, under some mild assumptions, continuous in the problem data (whereas purely real μ problems are not). This is reassuring from an engineering viewpoint since one is usually interested in robust performance problems (which therefore contain at least one complex block), or robust stability problems with some unmodeled dynamics, which are naturally covered with complex uncertainty. Thus in problems of engineering interest, the potential discontinuity of mixed μ should not arise.

Recent results in (Rohn and Poljak) show that a special case of computing μ with real perturbations only is NP complete. While these results do not apply to the complex only case, it is certainly true that the general mixed problem is NP hard as well. These results strongly suggest that it is futile to pursue exact methods for computing μ in the purely real or mixed case for

even moderate (less than 100) numbers of real perturbations, unless one is prepared not only to solve the real μ problem but also to make fundamental contributions to the theory of computational complexity. Furthermore, it may be that even approximate methods must have worst-case combinatoric complexity (Demmel).

These results do not mean, however, that “practical” algorithms are not possible, where “practical” means avoiding combinatoric (nonpolynomial) growth in computation with the number of parameters for all of the problems which arise in engineering applications. Practical algorithms for other NP hard problems exist and typically involve approximation, heuristics, branch-and-bound, or local search. Results presented in (Young, Newlin, et al, 1991) strongly suggest that an intelligent combination of all these techniques can yield a practical algorithm for the mixed problem.

Upper and lower bounds for mixed μ have recently been developed, and they take the form of generalizations of the bounds for the complex μ problem presented here (i.e. by applying the mixed μ bounds to complex μ problems one recovers the standard complex μ bounds). The upper bound was presented in (Fan, Tits, et al, 1991) and involves minimizing the eigenvalues of a Hermitian matrix. This can also be recast as a singular value minimization which involves additional scaling parameters to the complex μ upper bound. It is shown in (Young and Doyle, 1990) that the mixed μ problem can be recast as a real eigenvalue maximization and that this in turn can be tackled via a power algorithm, giving a lower bound for mixed μ . A practical computation scheme for these bounds has recently been developed (Young, Newlin, et al, 1992) and will be available shortly in a test version in conjunction with the μ -Tools toolbox (Balas, Doyle, et al, 1991).

The quality of these bounds, and their computational requirements as a function of problem size, are explored in (Young, Newlin, et al, 1991). While the bounds are usually accurate enough for engineering purposes, in a significant number of cases of interest, they are not. This is in contrast with the purely complex nonrepeated case, where no examples of problems with large gaps have been found. The use of Branch and Bound schemes to improve upon existing bounds has been suggested by several authors (see (Balakrishnan, Boyd, et al, 1991) and (Sideris and Peña, 1989, 1990) (de Gaston and Safonov, 1988) and references therein). There are some important issues and tradeoffs to be considered in implementing such a scheme, which can greatly impact the performance. A selection of results from a fairly extensive numerical study of these issues is presented in (Young, Newlin, et al, 1991), and a Branch and Bound scheme is proposed which should form the basis of a practical computation scheme for mixed μ . This will be further explored in (Newlin, Young and Doyle).

The upper and lower bounds from complex μ theory not only serve as computational schemes, but are theoretically rich as well. Connections between the bounds and various aspects of linear system theory have been established, and further work in this area appears to have great promise. A theoretical study of the mixed μ bounds may yield new insight as well, and this is a subject of current research. Initial results in this area are presented in (Young and Doyle), where it is seen that mixed μ inherits many of the (appropriately generalized) properties of complex μ , although as has already been seen, in some aspects the mixed μ problem can be fundamentally different from the complex μ problem.

Problems involving robustness properties of polynomials with coefficients perturbed by real pa-

rameters have received a great deal of attention in the literature. This type of robustness problem leads to a (real or) mixed μ problem. Several celebrated “Kharitonov-type” results have been proven for special cases of this problem, such as the “affine parameter variation” problem (see (Barlett, Hollet, et al, 1988) for example), and the solutions typically involve checking the edges or vertices of some polytope in the parameter space. It can be shown that restricting the allowed perturbation dependence to be affine leads to a real μ problem on a transfer matrix which is rank one.

The rank one mixed μ problem is studied in detail by Chen, Fan, et al, 1991, (see also the references therein). The authors develop an analytic expression for the solution to this problem, which is not only easy to compute, but has sublinear growth in the problem size. They are then able to solve several problems from the literature, noting that these problems can be treated as special cases of “rank one μ problems” and are thus “relatively easy to solve”. Even the need to check (a combinatoric number of) edges is shown to be unnecessary. While many of these results were apparently well-known, (Chen, Fan, et al, 1991) provides a direct comparison between the polynomial and μ -based approaches.

This rank one case is also studied by Young and Doyle, where it is shown that for such problems μ equals its upper bound and is hence equivalent to a convex problem. This reinforces the results of (Chen, Fan, et al, 1991) and offers some insight into why the problem becomes so much more difficult when we move away from the “affine parameter variation” case to the “multilinear” or “polynomial” cases (Sideris and Peña, 1989 and 1990). These correspond to μ problems which are not necessarily rank one, and hence may no longer be equal to the upper bound and so may no longer be equivalent to a convex problem. These results also underline why there are no practical algorithms based on “edge-type” theorems, as the results appear to be relevant only to a very special problem. Furthermore, even in the very special “affine parameter case” there are a combinatoric number of edges to check.

13.5 Generalizations of μ

In this section we review an alternative formulation of μ due to Fan and Tits (1986) and use it to consider one of several possible generalizations of μ . The most important motivation for this generalization comes from the model validation problem (see (Smith and Doyle, 1992), and (Newlin and Smith, 1991) for background).

For simplicity, the Fan-Tits formulation is considered here for the full block only case ($S = 0$). For any vector or matrix A with n rows let A_i denote the rows of A corresponding to the i th block of Δ . Thus A_i has m_i rows. Also, let $P := I_n$ be the identity matrix. An alternative expression for μ is

$$\mu = \max_x \{ \alpha : \alpha \|x_i\| \leq \|M_i x\| \quad \forall i \in \{1, \dots, F\} \} \quad (13.5)$$

To see that this is equivalent to (3.3) in Definition 3.1, note that when $\det(I - M\Delta) = 0$ there is an $x \neq 0$ that satisfies $(I - \Delta M)x = 0$. This x achieves the maximum in (13.5). Conversely, any x that achieves the maximum provides a way to constructing a Δ : set Δ_i equal to the dyad that satisfies $x_i = \Delta_i M_i x$.

An LMI formulation of the upper bound follows easily from (13.5). Again, we consider the full

block only case.

$$\begin{aligned}
& \alpha \leq \mu \\
& \iff \exists x \neq 0 : \alpha^2 \|x_i\|^2 \leq \|M_i x\|^2 \quad \forall i \\
& \iff \exists x \neq 0 : x^*(M_i^* M_i - \alpha^2 P_i^* P_i)x \geq 0 \\
& \iff \exists x \neq 0 : x^*(M^* D M - \alpha^2 D)x \geq 0 \quad \forall D \in \mathcal{D} \\
& \text{where } \mathcal{D} := \left(D = \sum_i d_i P_i^* P_i : d_i > 0 \quad \forall i \right) = \mathbf{D}
\end{aligned}$$

It follows that

$$\alpha > \mu \iff \exists D \in \mathcal{D} : M^* D M - \alpha^2 D < 0 \quad (13.6)$$

This is the same as the LMI in equation (3.11).

The generalization of μ that we will study depends on a block structure as before along with an index that specifies certain blocks as special or distinguished (Newlin and Smith, 1991). As an example, consider equation 13.5 in the case of two full blocks:

$$\mu = \max_x \{ \alpha : \alpha \|x_1\| \leq \|M_1 x\| \quad \& \quad \alpha \|x_2\| \leq \|M_2 x\| \}$$

Suppose the second block has been designated as special. Then the generalization is

$$\mu = \max_x \{ \alpha : \alpha \|x_1\| \leq \|M_1 x\| \quad \& \quad \alpha^{-1} \|x_2\| \geq \|M_2 x\| \}$$

In this example, the designation of the second block as special means that the direction of the second inequality is reversed and the scaling changed.

The lower bound for this generalization of μ , though notationally awkward, is very similar to the standard lower bound, and a power algorithm is being investigated. There is no upper bound similar to the $\bar{\sigma} \left(D^{\frac{1}{2}} M D^{-\frac{1}{2}} \right)$ upper bound, but there is a generalization of the LMI above. Again consider our two block example.

$$\begin{aligned}
& \alpha \leq \mu \\
& \iff \exists x \neq 0 : \begin{cases} \alpha^2 \|x_1\|^2 \leq \|M_1 x\|^2 \\ \alpha^{-2} \|x_2\|^2 \geq \|M_2 x\|^2 \end{cases} \\
& \iff \exists x \neq 0 : \begin{cases} x^*(M_1^* M_1 - \alpha^2 P_1^* P_1)x \geq 0 \\ x^*(M_2^* M_2 - \alpha^{-2} P_2^* P_2)x \leq 0 \end{cases} \\
& \iff \exists x \neq 0 : x^*(M^* D M - P^2(\alpha) D)x \geq 0 \quad \forall D \in \mathcal{D} \\
& \text{where } \mathcal{D} := (d_1 P_1^* P_1 + d_2 P_2^* P_2 : d_1 > 0; d_2 < 0) \\
& \text{and } P(\alpha) = \alpha^2 P_1^* P_1 + \alpha^{-2} P_2^* P_2
\end{aligned}$$

It follows that

$$\alpha > \mu \iff \exists D \in \mathcal{D} : M^* D M - P(\alpha)^2 D < 0$$

We see that D is just as in the case of standard LMI upper bound for μ except that we require for some blocks that $D_i < 0$ rather than $D_i > 0$. It is expected that algorithms for computing positive definite solutions to LMIs will be easily generalized to solve this problem.

14 Acknowledgements

The authors gratefully acknowledge helpful discussions with Blaise Morton, Sigurd Skogestad, Peter Young, Michael Fan, and Kemin Zhou and excellent comments on this paper from Carolyn Beck and Jorge Tierno. Thanks also to Matt Newlin, Sharon Laubach, Brian Clendenin, and Sonja Glavaski for useful suggestions. Financial support for this work came from the National Science Foundation (grants ECS-8909499, CTS-9057420, and ECS-8657814), AFOSR, ONR, NASA, Honeywell, Rockwell International, and the Berkeley Engineering Fund.

15 References

- AndAJM:** B. Anderson, P. Agathoklis, E. Jury, and M. Mansour, “Stability and the matrix Lyapunov equation for discrete 2-dimensional systems,” *IEEE Trans. on Circuits and Sys.*, vol. 33, no. 3, pp. 261-267, March 1986.
- BahD:** B. Bamieh and M. Dahleh, “On robust stability with structured time-invariant perturbations,” *Center for Control Engineering and Computation*, UC Santa Barbara, CCEC-92-0331, May 1992.
- BalBB:** V. Balakrishnan, S. Boyd, and S. Balemi, “Branch and Bound algorithm for computing the minimum stability degree of parameter-dependent linear systems,” technical report, Information Systems Laboratory, Stanford University, 1991.
- BalDGPS:** G. Balas, J. Doyle, K. Glover, A. Packard, and R. Smith, “The μ Analysis and Synthesis Toolbox,” MathWorks and MUSYN, 1991.
- BarHL:** A.C. Barlett, C.V. Hollot, and H. Lin, “Root locations of an Entire Polytope of Polynomials: It suffices to check the edges,” *Mathematics of Control, Signals, and Systems*, vol. 1, no. 1, 1988.
- BarKSTB:** B. Barmish, P. Khargonekar, Z. Shi, and R. Tempo, “Robustness margin need not be a continuous function of the problem data,” *Systems and Control Letters*, vol. 15, pp. 91-98, 1989.
- Beck:** C. Beck, “Computational Issues in Solving LMIs,” *Proc. of the 30th IEEE Conf. on Decision and Control* pp. 1259-1260, 1991.
- BoyD:** S. Boyd and C. Desoer, “Subharmonic functions and performance bounds on linear time-invariant feedback systems”, *IMA J. of Mathematical Control and Information*, volume 2, pp. 153-170, 1985.
- BoEl** Boyd, S., and El Ghaoui, L., 1991, “Method of Centers for Minimizing Generalized Eigenvalues”, to appear in *Linear Algebra and its Applications*, special issue on Numerical Linear Algebra Methods in Control, Signals and Systems.
- BoyY:** S. Boyd, and Q. Yang, “Structured and simultaneous Lyapunov functions for system stability problems,” *Int. J. Control*, vol. 49, no. 6, pp. 2215-2240, 1989.

- CheD:** M.J. Chen and C.A. Desoer, "Necessary and sufficient condition for robust stability of linear distributed feedback systems," *Int. J. Control*, vol. 35, no. 2, pp. 255-267, 1982.
- CheFN:** J. Chen, M. K. H. Fan, and C. N. Nett, "The structured singular value and stability of uncertain polynomials: A missing link," in ASME annual winter meeting, Atlanta GA, December 1991.
- DahK** M.A. Dahleh and M.H. Khammash, "Controller Design for Plants With Structured Uncertainty," *submitted to Automatica Special Issue on Robust Control*, 1991.
- DanKL:** R.W. Daniel, B. Kouvaritakis, and H. Latchman, "Principal direction alignment: a geometric framework for the complete solution to the μ problem," *IEE Proceedings*, vol. 133, part D, no. 2, pp. 45-56, March 1986.
- DavKW:** C. Davis, W. Kahan, and H. Weinberger, "Norm preserving dilations and their applications to optimal error bounds," *SIAM Journal on Numerical Analysis*, vol. 19, no. 3, pp. 445-469, June 1982.
- deGS:** R. de Gaston and M. Safonov, "Exact calculation of the multiloop stability margin," *IEEE Trans. Auto. Control*, vol. 33, pp. 156-171, 1988.
- Dem:** J. Demmel, "The componentwise distance to the nearest singular matrix," to appear in *SIAM Journal on Matrix Analysis and Applications*.
- DesV:** C.A. Desoer and M. Vidyasagar, "Feedback Systems: Input-Output Properties," *Academic Press*, New York, 1975.
- Doy:** J.C. Doyle, "Analysis of feedback systems with structured uncertainties", *IEE Proceedings*, vol. 129, Part D, no. 6, pp. 242-250, Nov. 1982.
- Doy:** J.C. Doyle, "Matrix Interpolation Theory and \mathcal{H}_∞ Performance Bounds," *Proc. American Control Conference*, Boston, MA, 1985 (a).
- Doy:** J.C. Doyle, "Structured uncertainty in control system design", *IEEE Conf. on Decision and Control*, Ft. Lauderdale, December 1985 (b).
- DoyGKF:** J. Doyle, K. Glover, P. Khargonekar, and B. Francis, "State Space Solutions to \mathcal{H}_2 and \mathcal{H}_∞ Control Problems," *IEEE Trans. Auto. Control*, vol. 34, no. 8, pp. 831-847, August, 1989.
- DoyP:** J.C. Doyle and A. Packard, "Uncertain multivariable systems from a state space perspective", *Proc. of American Control Conference*, June 1987, pp. 2147-2152.
- DoyPZ:** J. Doyle, A. Packard, and K. Zhou, "Review of LFTs, LMIs and μ ," *Proc. of the 30th IEEE Conf. on Decision and Control* pp. 1227-1232, 1991.
- DoyS:** J.C. Doyle and G. Stein, "Multivariable feedback design: Concepts for a classical/modern synthesis," *IEEE Trans. Auto. Control*, vol. AC-26, pp. 4-16, Feb. 1981.
- DoyWS:** J.C. Doyle, J. Wall and G. Stein, "Performance and robustness analysis for structured uncertainty," *IEEE Conf. on Decision and Control*, Dec. 1982, pp. 629-636.

- DunS:** N. Dunford and J.T. Schwartz, “Linear Operators,” Interscience Publishers, Wiley, New York, 1958 and 1963.
- FanT1:** M.K.H. Fan and A.L. Tits, “Characterization and Efficient Computation of the Structured Singular Value”, *IEEE Trans. Auto. Control*, vol. AC-31, no. 8, pp. 734-743, Aug. 1986.
- FanTD:** M. Fan, A. Tits, and J. Doyle, “Robustness in the presence of joint parametric uncertainty and unmodeled dynamics,” *IEEE Trans. Auto. Control*, vol. 36, Jan. 1991, pp. 25-38.
- FooP:** Y.K. Foo and I. Postlethwaite, “Extensions of the small- μ test for robust stability,” *IEEE Trans. Auto. Control*, vol. 33, no. 2, Feb. 1988, pp. 172-176.
- FreLC:** J.S. Freudenberg, D.P. Looze and J.B. Cruz,, “Robustness analysis using singular value sensitivities”, *Int. J. Control*, vol. 35, no. 1, pp. 95-116, 1982.
- Hel:** W. Helton, “A numerical method for computing the structured singular value,” *Systems and Control Letters*, pp. 21-26, 1988.
- IEEE** Special issue on linear multivariable control systems, *IEEE Trans. Auto. Control*, vol. 26, pp. 621-623, Feb. 1981.
- Jarr** Jarre, F., 1991, “An Interior-Point Method for Minimizing the Maximum Eigenvalue of a Linear Combination of Matrices”, Technical Report SOL 91-8, Stanford, California.
- Kat:** T. Kato, “A Short Introduction to Perturbation Theory for Linear Operators,” 1982, Springer Verlag, New York.
- Kha:** V.L. Kharitonov, “Asymptotic Stability of an Equilibrium Position of a Family of Systems of Linear Differential Equations,” *Differential Equations*, vol. 14, 1979, pp. 1483-1485.
- KhaK:** P. Khargonekar and I. Kaminer, “Robust Stability Analysis with Structured Norm Bounded Unstable Uncertainty,” *1991 Amer. Control Conf.*, pp. 2700-2701, Boston, MA, June 1991.
- KhaP:** M. Khammash and J. B. Pearson, “Performance Robustness of Discrete-Time Systems with Structured Uncertainty”, *IEEE TAC*, vol. AC-36, no. 4, pp. 398-412, 1991.
- KhaPZ:** P. Khargonekar, I. Petersen and K. Zhou, “Robust stabilization of uncertain linear systems: quadratic stability and \mathcal{H}_∞ control theory,” *IEEE Trans. Auto. Control*, vol. 35, pp. 356-361, March, 1990.
- LuZD:** W. M. Lu, K. Zhou, and J. Doyle, “Stability and stabilization of LSI multidimensional systems,” *Proc. of the 30th IEEE Conf. on Decision and Control* pp. 1239-1244, 1991.
- Lue:** D. Luenberger, “Optimization by vector space methods,” John Wiley and Sons, 1969.
- MorD:** B. Morton and J. Doyle, private communication, 1985.
- MorM:** B. Morton and R. McAfoos, “A Mu-Test for Real-Parameter Variations,” *Proc. of American Control Conference*, pp. 135-138, Boston, 1985.

- NeNe1** Nesterov, Yu.E., and Nemirovsky, A.S., 1989, **Self-Concordant Functions and Polynomial Time Methods in Convex Programming**, USSR Academy of Science, Central Econ. and Math. Inst., Moscow.
- NeNe2** Nesterov, Yu.E., and Nemirovsky, A.S., 1990, **Optimization over Positive Semidefinite Matrices: mathematical background and users manual**, USSR Academy of Science, Central Econ. and Math. Inst., Moscow.
- NewS:** M. Newlin and R. Smith, "Model validation and a generalization of μ ," *Proc. of the 30th IEEE Conf. on Decision and Control* pp. 1257-1258, 1991.
- NewYD:** M. P. Newlin, P. M. Young, and J. C. Doyle, "Improving the bounds for mixed μ problems via Branch and Bound techniques," manuscript in preparation.
- OsB:** E.E. Osborne, "On Preconditioning of Matrices," *J. Assoc. Comp. Mach.*, 7, pp. 338-345, 1960.
- Ove:** M. Overton, "Large-Scale Optimization of Eigenvalues," NYU Computer Science Department Report, #505, May, 1990.
- Pac** A. Packard, "What's new with μ ," PhD Thesis, Mechanical Engineering, University of California, Berkeley, 1988.
- PacB:** A. Packard and J. Whitney Balsamo, "A maximum modulus theorem for linear fractional transformations," *Systems and Control Letters*, vol. 11, pp. 365-367, November, 1988.
- PacD:** A. Packard and J. Doyle, "Quadratic stability with real and complex perturbations," *IEEE Trans. Auto. Control*, vol. 35, no. 2, pp. 198-201, February, 1990.
- PacFD:** A. Packard, M. Fan, and J. Doyle, "A power method for the structured singular value," *IEEE Conf. on Decision and Control*, pp. 2132-2137, Austin, TX, December 1988.
- PacP:** A. Packard and P. Pandey, "Continuity of the real/complex structured singular value," 29th Allerton Conference on Control Communication and Computing, pp. 875-884, 1991; also submitted to *IEEE Trans. Auto. Control*, July, 1991.
- PacT:** A. Packard and J. Teng, "Robust stability with time-varying perturbations," 28th Allerton Conference, October, pp. 765-767, 1990.
- PacZ:** A. Packard and K. Zhou, "Improved upper bounds for the structured singular value," *28th IEEE Conference on Decision and Control*, Tampa, FL, pp. 934-935, December, 1989.
- PacZPLB:** A. Packard, K. Zhou, P. Pandey, J. Leonhardsen, G. Balas, "Optimal I/O Similarity Scaling for Full-Information and State-Feedback Problems," submitted to *Systems and Control Letters*, October 1991.
- Poo:** K. Poolla, personal communication, September, 1991.
- Pop:** V.M. Popov, "Absolute stability of nonlinear systems of automatic control", *Automat. Remote Control*, vol. 22, pp. 857-875, 1962.
- Pow:** S.C. Power "Hankel operators on Hilbert space," Pitman, London, 1982.

- Red1:** R. Redheffer, "Inequalities for a matrix Riccati equation," *Journal of Mathematics and Mechanics*, vol. 8, no. 3, 1959.
- Red2** Redheffer, "On a certain linear fractional transformation," *em J. Math. Phys.*, vo. 39. pp. 269-286, 1960.
- RohP:** J. Rohn and S. Poljak, "Radius of nonsingularity," to appear in *Mathematics of Control, Signals and Systems*.
- RotCDP** M.A. Rotea, M. Corless, D. Da, I. Petersen, "Systems with structured uncertainty: relations between quadratic and robust stability," *1991 Allerton Conference on Communication Control, and Computing*, pp. 885-894; also to appear *IEEE Trans. Auto. Control*, February 1993.
- RotK:** M.A. Rotea, and P.P. Khargonekar, "Stabilization of uncertain systems with norm bounded uncertainty - A control Lyapunov Function approach," *SIAM J. Control Optim.*, vol. 27, no. 6, pp. 1462-1476, 1989.
- Saf1:** M.G. Safonov, "Tight bounds on the response of multivariable systems with component uncertainty," *1978 Allerton Conference on Communication, Control and Computing*, pp. 451-460.
- Saf2:** M.G. Safonov, "Stability and Robustness of Multivariable Feedback Systems," *MIT Press*, 1980.
- Saf3:** M.G. Safonov, "Stability margins of diagonally perturbed multivariable feedback systems," *Proceedings of the IEE*, vol. 129, Part D, no. 6, pp. 251-256, Nov. 1982.
- Saf4:** M.G. Safonov, "Stability of interconnected systems having slope bounded nonlinearities," *6th International Conf. on Analysis and optimization of systems*, Nice, France, June 19-22, 1984.
- Saf5:** M.G. Safonov, "Optimal diagonal scaling for Infinity norm optimization," *Systems and Control Letters*, vol. 7, pp. 257-260, 1986.
- SafD:** M.G. Safonov and J.C. Doyle, "Minimizing conservativeness of robustness singular values," in *Multivariable Control*, S.G. Tzafestas, Ed. New York: Reidel, 1984.
- SafL:** M.G. Safonov, and V.X. Le, "An alternative solution to the \mathcal{H}_∞ optimal control problem," *Systems and Control Letters*, vol. 10, pp. 155-158, 1988.
- SezO:** R. Sezginer and M. Overton, "The largest singular value of $e^X A e^{-X}$ is convex on convex sets of commuting matrices," *IEEE Trans. on Auto. Control*, vol. 35, pp. 229-230, February, 1990.
- SiddeG:** A. Sideris and R.R.E. de Gaston, "Multivariable Stability Margin Calculation with Uncertain Correlated Parameters," *IEEE Conf. on Decision and Control*, pp. 766-773, Greece, December 1986.
- SidP:** A. Sideris and R. Sanchez Peña, "Robustness margin calculations with dynamic and real parametric uncertainty," *IEEE Trans. Auto. Control*, vol. 35, no. 8, pp. 970-974, August 1990.

- SidP2:** A. Sideris, and R. S. Sánchez Peña, “Fast computation of the multivariable stability margin for real interrelated uncertain parameters,” *IEEE Trans. Auto. Control*, vol. 34, no. 12, pp. 1272-1276, December, 1989.
- Sko:** S. Skogestad, personal communication, 1987.
- SkoMD:** S. Skogestad, M. Morari, and J. Doyle, “Robust control of ill-conditioned plants: high-purity distillation,” *IEEE Transactions on Auto. Control*, vol. 33, no. 12, pp. 1092-1105, December 1988
- SmiD:** R. Smith and J. Doyle, “Model validation: A connection between robust control and identification,” to appear, *IEEE Transactions on Auto. Control*, vol. 37, no. 7, July 1992.
- SteD:** G. Stein and J. Doyle, “Beyond singular values and loopshapes,” *AIAA Journal of Guidance and Control*, January, 1991.
- Wil:** J.C. Willems, “Least Squares Stationary Optimal Control and the Algebraic Riccati Equation”, *IEEE Trans. Auto. Control*, vol. 16, no. 6, pp. 621-634, December 1971 (a).
- Wil2** J. C. Willems, *The Analysis of Feedback Systems*, Cambridge, MA: MIT Press, 1971 (b).
- Will:** J.L. Willems, “The circle criterion and quadratic Lyapunov functions for stability analysis,” *IEEE Trans. Auto. Control*, vol. 18, pp. 184, April 1973.
- You:** P. Young, personal communication, February, 1992.
- YouD1:** P. M. Young and J. C. Doyle, “Computation of μ with real and complex uncertainties,” *Proc. of the 29th IEEE Conf. on Decision and Control*, pp. 1230-1235, 1990.
- YouD2:** P. M. Young and J. C. Doyle, “Properties of the mixed μ problem and its bounds,” manuscript in preparation.
- YouND1:** P. M. Young, M. P. Newlin, and J. C. Doyle, “ μ analysis with real parametric uncertainty,” *Proc. of the 30th IEEE Conf. on Decision and Control*, pp. 1251-1256, 1991.
- YouND2:** P. M. Young, M. P. Newlin, and J. C. Doyle, “Practical computation of the mixed μ problem,” to appear in *American Control Conference*, 1992.
- Zam:** G. Zames, “On the input-output stability of nonlinear time-varying feedback systems, parts I and II,” *IEEE Trans. Auto. Control*, vol. 11, pp. 228-238, and 465-476, 1966.
- ZhoK:** K. Zhou and P. Khargonekar, “Stability robustness bounds for linear state-space models with structured uncertainty,” *IEEE Trans. Auto. Control*, vol. 31, no. 7, pp. 621-623, July 1987.

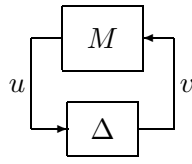
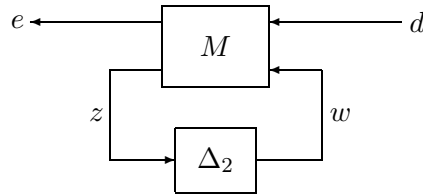
Figure 1: $M - \Delta$ Feedback Connection

Figure 2: Linear Fractional Transformation

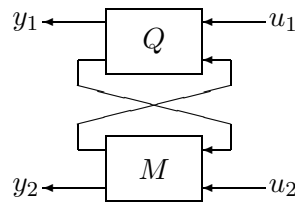


Figure 3: General Star Product

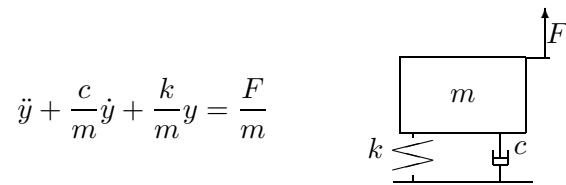


Figure 4: Mass-Spring-Damper System

	F=0	F=1	F=2	F=3	F=4
S=0		YES	YES Section 9.1	YES Section 9.3	NO Section 9.2
S=1	YES	YES Section 9.4	NO Section 9.6	NO	NO
S=2	NO Section 9.5	NO	NO	NO	NO

Table 1: Guaranteed equality between μ and the upper bound

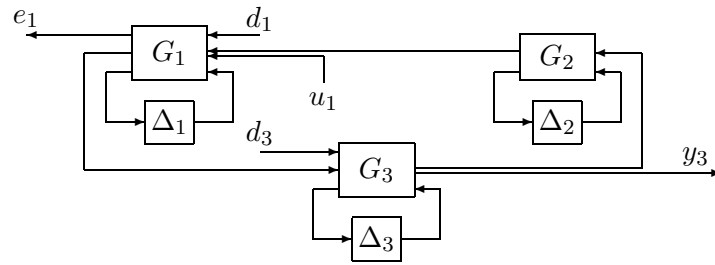


Figure 5: Example Interconnection of LFT's

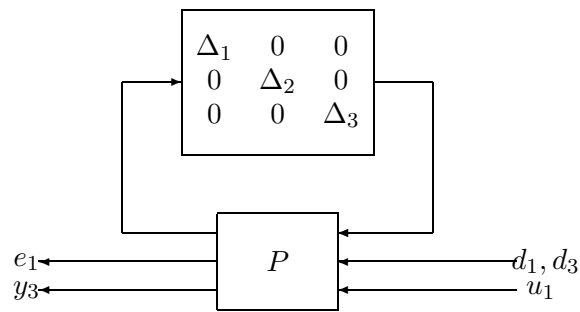


Figure 6: Macroscopic representation of Figure 5

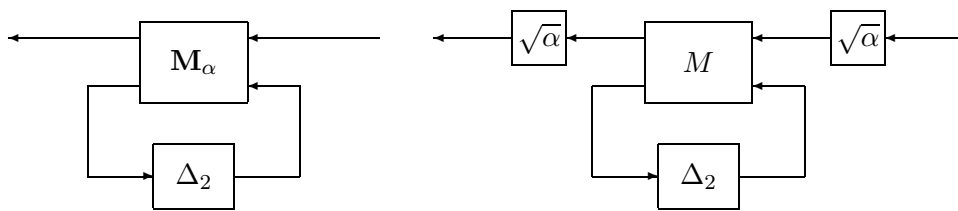


Figure 7: Scaling for Main Loop Theorem

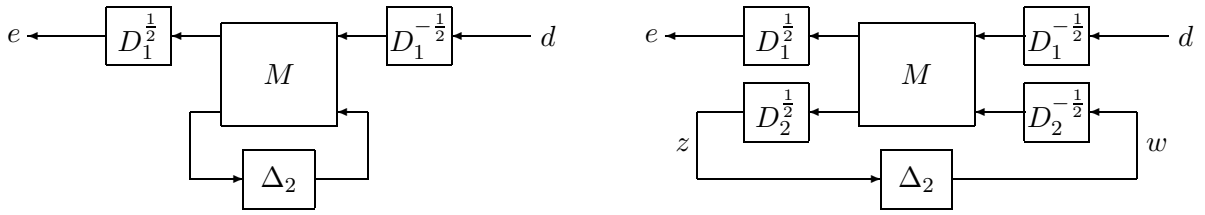


Figure 8: Equivalent LFT's

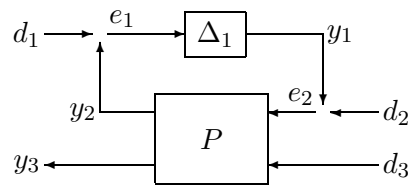


Figure 9: Uncertain System for Robustness Tests

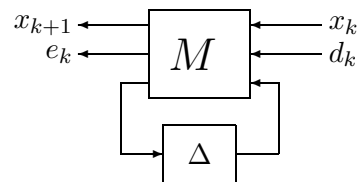


Figure 10: Uncertain System as an LFT